



**D100AHA**  
**D100AHG**  
**D120AHA**  
**D120AHG**  
**D150AHG**

**OPERATOR'S  
MANUAL**

**ENGLISH**  
Original Manual

**M O P 1 8 0 6 1 4 0 2**





**D100AHA**  
**D100AHG**  
**D120AHA**  
**D120AHG**  
**D150AHG**

**Original Manual**



D100AHA / D100AHG  
D120AHA / D120AHG  
D150AHG



## Foreword

■ Thank you for choosing this AUSA dumper model which offers the best levels of performance, safety and working comfort. Remember that you are the key to maintaining these characteristics. Correct use of the dumper will enable you to take full advantage of the features it has to offer.

You should read and understand this Manual before operating the dumper. Its purpose is to provide instructions for those persons in contact with the machine and especially for the machine's operator. Its content will help you to better understand the AUSA dumper, and teach all you need to know about starting it, driving techniques, maintenance and care, designed uses of the dumper and safety instructions to be followed.

AUSA cannot be held responsible for any damages caused by the improper use of the dumper.

For any queries, complaints or spare parts orders, contact your Official AUSA Representative or Dealer.

For further information you may call, write, FAX or email to:

**AUSA Center, S.L.U.**

P.O.B. 194

08243 MANRESA (Barcelona), SPAIN

Tel. 34-938 747 552 / 938 747 311

Fax 34-938 736 139 / 938 741 211 / 938 741 255

E-mail: [ausa@ausa.com](mailto:ausa@ausa.com)

Web: <http://www.ausa.com>

AUSA is continually improving its products and reserves the right to make such improvements without incurring any obligation to make changes to dumpers previously sold. Therefore, claims cannot be made based on the data, illustrations and descriptions set forth in this manual.

**Use only original AUSA spare parts.** Only thus can you guarantee that the dumper will continue to give the same level of technical performance as when purchased.

No changes should be made to the dumper without prior authorisation from the manufacturer.

Keep this manual in the document holder situated under the right engine cover (**fig. 1**).



(fig. 1)



**D100AHA / D100AHG**  
**D120AHA / D120AHG**  
**D150AHG**

## Table of Contents

Designed use of the dumpers .....	<b>5</b>
Special safety messages .....	<b>6</b>
Identification plates and decals .....	<b>11</b>
Specifications .....	<b>12</b>
How to identify your dumper .....	<b>15</b>
Controls / Instruments / Equipment .....	<b>16</b>
Operating the dumper .....	<b>21</b>
Break in period .....	<b>25</b>
Pre-operation check .....	<b>26</b>
Transporting the dumper .....	<b>27</b>
Liquids and lubricants .....	<b>29</b>
Special procedures .....	<b>31</b>
Periodic maintenance operations .....	<b>33</b>
Greasing points .....	<b>53</b>
Wiring diagram .....	<b>54</b>
Hydraulic diagram AHA (Auxiliaries) .....	<b>60</b>
Hydraulic diagram AHG (Auxiliaries) .....	<b>61</b>
REXROTH hydraulic diagram (Transmission) .....	<b>62</b>
SAUER hydraulic diagram (Transmission) .....	<b>63</b>
EC certificate of conformity .....	<b>64</b>

D100AHA / D100AHG  
D120AHA / D120AHG  
D150AHG



## Designed use of the dumpers

- The dumpers have been designed and manufactured for the transport of loose materials, (mortar, cement, sand, gravel and rubble or materials from demolitions).

Any other use should be considered outside of the intended use and therefore improper.

Close adherence to the operation, maintenance and repair conditions specified by the manufacturer is essential for good use of this vehicle.

Driving, maintenance and repair of the dumper must only be entrusted to duly trained personnel, who have the required tools and know the intervention and safety procedures relating to the dumper.

Health and safety at work and accident prevention standards should be respected during all transport, maintenance or repair operations. When driving on public roads current legislation must be adhered to (Highway Code).

AUSA shall not be responsible for any possible harm caused by any modification carried out on the dumper without their express authorisation.

### ■ Improper use

Improper use is understood to be the use of the dumper in such a way that it does not meet with the criteria and instructions of this manual and in such a way that said use may cause harm to persons or items.

The following are some of the most frequent and dangerous instances of improper use:

- Transporting people in the skip.
- Failing to comply scrupulously with the instructions for use and maintenance set out in this manual.
- Overloading
- Working on unstable, unconsolidated ground or on the edge of ditches and trenches.
- Using accessories and equipment for purposes other than those they are designed for.
- Using accessories and equipment not manufactured or authorized by AUSA.



## Special safety messages

■ AUSA manufactures their dumpers in accordance with demands for intrinsic protection, as established in current law for countries of the European Economic Community, against dangers of any kind, which may present a risk to health or life, whenever the machine is used and maintained in accordance with these directives. Any hazard caused by improper use, not in compliance with these instructions or others specifically provided with the dumper will be responsibility of the user and not AUSA.

This section gives instructions on how the dumper must be used as per that contained in the 2006/42/EC Machine Safety Directive.

### As the vehicle operator, think...

- Before you begin using a dumper that you are not yet familiar with, you should read this operator manual carefully and consult your superior if you have any doubts (**fig. 1**). The dumper should only be used by authorized and duly trained personnel.
- Make sure that you are issued with all the necessary protective gear to enable you to carry out your work safely, for instance: hard hat, ear protectors, warm clothes, reflective equipment, goggles, etc. (**fig. 2**)
- The operation of the dumper whilst wearing bracelets, chains, loose clothing, long hair which is not tied back, etc. is not recommended due to the risk of being caught in controls, rotating parts, cracks, etc.

### Depending on the work area, remember...

- If there is a risk of fire or explosion in the working area, either because of goods stored or because of possible fluid or gas leaks, check that the dumper is fitted with a sufficient degree of fire protection.
- If you have to work in closed spaces, make sure that the area is well ventilated in order to prevent the excessive build-up of exhaust fumes. Always turn the engine off when it is not needed.
- To drive the dumper on public roads, all necessary approvals and licenses must be obtained in accordance with the current country legislation, also incorporating the signaling and safety elements included in the legislation.
- Current legislation does not require the mounting, as standard, of a structure for protection from falling objects. However, if you must use the dumper in areas that manifest a risk of this type, the same legislation indicates that you must equip the machine with said structure.
- Use of the dumper without lighting is permitted in full daylight or in areas which are sufficiently lit.



(fig. 1)

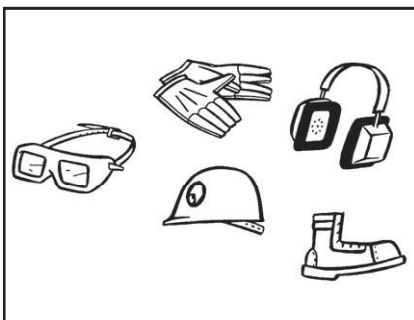

(fig. 2)

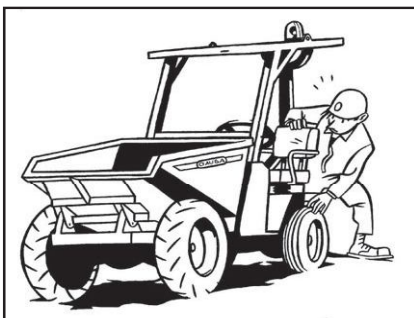

(fig. 3)

### When starting up the dumper (fig. 3)

- Before starting work with the dumper, clean up any possible oil or fuel which may have leaked, clean and remove any grease from your hands and the soles of your shoes and remember to check the following items:
- Tyre pressure and tread condition
- Check brake functioning.
- Check for any leaks in the hydraulics, fuel and cooling systems, etc.
- Check that all protectors, covers and safety props are correctly positioned and properly attached.
- Check that there are no cracks or other structural defects visible to the naked eye.



D100AHA / D100AHG  
D120AHA / D120AHG  
D150AHG



## ! Special safety messages



(fig. 1)

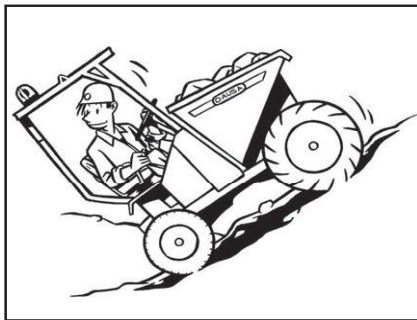

(fig. 2)



(fig. 3)

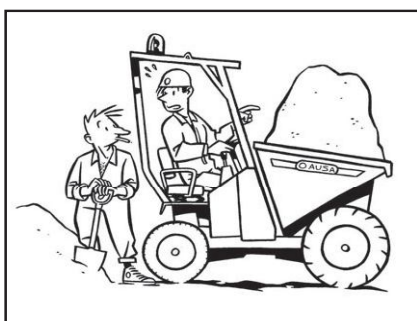

(fig. 4)

- Check the correct operation of all controls.
  - Check the following fluid levels:
    - fuel
    - brake fluid
    - hydraulic oil
    - coolant
  - Check the seatbelts and their mountings are in good condition and properly fixed.
  - Carefully inspect the condition of this device paying special attention to:
    - Cuts or threading on the belt.
    - Wear or damage to anchor points
    - Poor functioning of the seat belt buckle or the retracting roller
    - Loose threads or poor stitching
  - Check that all covers, locks and other safety elements are correctly positioned.
  - Check the correct functioning of alarms and signaling devices (for example: acoustic warning, obstruction indicator for the air admission filter, etc.)
  - Check that all the information and safety advice plates on the dumper are clean and in good condition.
  - Check that the lighting and signaling system is clean and working properly.
  - Check the electric battery connections and the level of electrolyte.
  - Adjust the seat position so that you are comfortable and can easily reach the controls.
  - Do not start the engine or operate the controls unless you are seated in the cab.
  - For your safety in the case of overturning, do not forget to correctly adjust and fasten the seat belt.
  - Keep the driving area clear of all objects or tools that could move about and might obstruct a control and prevent you from carrying out a maneuver when required.
- (fig. 1)**
- Although not recommended, if you use a spray with ether to start the dumper in low temperatures, do so in well ventilated areas, do not smoke during the operation and spray small amounts.
  - These pressurized containers should be stored away from heat sources, and when empty they should neither be thrown on fires nor crushed as there may be a risk of explosion.
  - Always stop the engine before refueling and never smoke during the process. Do not mix gasoline or alcohol with the fuel
- **When operating the dumper, do not forget... (fig. 2, 3, 4)**
- If you notice any anomaly while using the dumper, inform your superior or maintenance service immediately.
  - Keep hands, feet and the whole body in general inside the area provided for the operator.
  - Pay special attention to work on slopes, move slowly, avoid being situated crosswise and do not operate slopes which exceed the recommended gradient. A slope within the recommended gradient does not mean that this slope can be maneuvered on with absolute safety under any load, terrain or handling conditions. Descend slopes in reverse gear, with the load, therefore, in the most stable direction **(fig. 2)**
  - It is not recommended to operate on slopes greater than 20% where the ground is wet or 30% where it is dry.
  - Never descend a slope with the transmission lever in neutral.
  - Give way to any pedestrians you might come across while driving.
  - The dumper must not be used to transport people, other than the driver, unless adequate seats have been provided **(fig. 3)**
  - Do not overload the dumper. Carry out maneuvers gently, especially when changing direction on slippery ground.
  - Ensure that you have good visibility of the track, if the load obstructs visibility, drive in reverse gear and increase precautions **(fig. 4)**



## Special safety messages

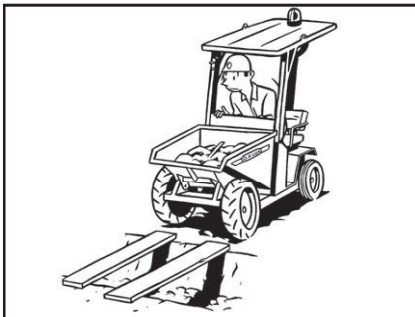

(fig. 1)

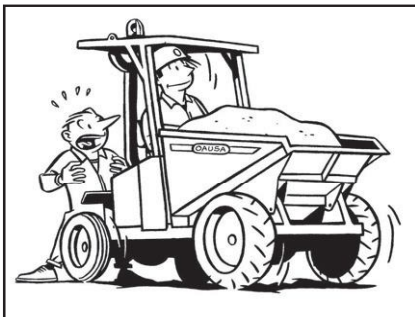

(fig. 2)

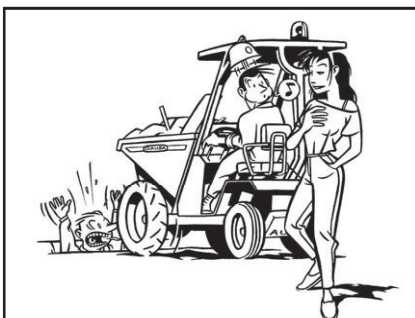

(fig. 3)



(fig. 4)

- When approaching a crossroads with poor visibility, slow down, sound your horn and move forwards slowly in accordance with the amount of visibility available.
- The speed of the dumper should be adjusted at all times to the work conditions and the area where it is being carried out. Regularly driving the machine at maximum speed may represent a danger to the operator and to his or her surroundings.
- Check that the resistance of the ground on which you are driving is sufficient for the loaded dumper, in particular on access to bridges, embankments, slabbed areas, loading areas, etc. **(fig. 1)**.
- Before reversing the dumper, the operator should check that doing so will not put at risk either the machine itself or nearby people or objects. **(fig. 2)**
- Do not drive with the skip raised.
- Do not activate two skip movements simultaneously.
- Keep your mind completely on the job in hand. The safety of both the driver and others depends on the care taken when driving. **(fig. 3)**
- When driving on public roads with a swing skip dumper, its longitudinal axis should be in the direction of travel.
- Depending on the ground, try to raise as little dust as possible while driving.
- The dumper is not a machine designed for towing other dumpers. If this is unavoidable, place a certain amount of load in the skip to ensure traction.
- Drive carefully and at a reduced speed; and if the trailer is not fitted with an inertia brake, make sure that the brakes are strong enough for both the dumper mass and that of the trailer.
- If the dumper has the possibility of two axle traction, consider that this must only be connected when required for surmounting a sloping obstacle or a slippery surface. Drive at a reduced speed in order to preserve the tyres and do not subject the traction-steering unit to excessive workloads.

### ■ Take care when loading and unloading the dumper...

- Do not empty the contents of the skip near a bank which is not reinforced, and unless there is a safety stop bar for the wheels at a safe distance from the edge. An 8 cm. side boarding cannot be considered an acceptable stopping device **(fig. 4)**.
- When tipping the load of a dumper, the center of gravity continually moves and the condition of the ground and the prudence of the operator are essential for the stability of the machine.
- When the dumper is loaded by shovel, crane or other similar external methods, the driver must leave the cab **(fig. 1 next page)**
- Perform the unloading maneuver progressively, maintaining the stability of the dumper. Avoid transporting materials which would stick to the dumper (for example: clayey loam) or that would get stuck in the dumper (for example: blocks of stone), as the loss of control which may be produced in the tipping maneuver places the stability of the dumper at risk.

D100AHA / D100AHG  
D120AHA / D120AHG  
D150AHG



## ! Special safety messages

### ■ When leaving the vehicle....

- Turn the engine off and switch off the ignition.
- Place the skip in the horizontal resting position.
- Place all controls in the neutral standby position.
- Put the parking brake on.
- Lock all mechanisms which impede use of the vehicle by unauthorized persons; the starter circuit in particular, by removing the ignition key **(fig. 2)**.
- If you must leave the dumper on a slope, in addition to putting the parking brake on, immobilize the wheels with suitable chocks.
- Leave the dumper in areas specifically designated for this purpose, and not where it prevents people from passing or blocks exits or access to stairways or emergency equipment.
- As the dumper has an articulated chassis, when leaving it, always leave it in a straight position.

### ■ Good conservation is safety guaranteed, for that reason ...

- Never stop carrying out dumper maintenance. Specialized personnel should be assigned to this job, equipped with the necessary tools and appropriate instructions.
- Only authorized personnel should carry out maintenance and repair work.
- Unless unavoidable, all attention to the dumper should be done with the engine switched off, the skip unloaded, and all the immobilizing and locking devices engaged.
- Some operations are easier done with the skip raised. Before doing so, precautions must be taken to prevent it from accidentally tipping using the safety props designed for this purpose which are provided in each dumper model **(fig. 3)**
- Before disconnecting fluid systems, make sure there is no pressure in them and take steps to avoid unexpected spills. Never use a naked flame to check fluid levels and leaks.
- Regular checks should be carried out on the hydraulic system to detect any possible leaks or misalignment on the safety valves which could lead to a risk situation.
- Regular checks should also be carried out on all those elements whose excessive wear or ageing could lead to a risk situation, for example: hydraulic hoses, brake pads, tyres pattern, etc.
- In the case of the roof or operator protection arch has suffered an impact that has produced any permanent deformity, as this is a safety element it must therefore be replaced for a new one.
- All identification, instruction and warning plates attached to the dumper must be kept in a perfectly readable condition.
- Any modification which affects the capacity and safety of the dumper must be authorized by the machine manufacturer or by a responsible manufacturer, modifying where necessary the instruction manuals and plates.
- The manufacturer will not be held responsible for any incidences or accidents caused by the use of non-original spare parts or by repairs carried out by unauthorized workshops.
- When replacing tyres, ensure that they are the correct replacements and follow the tyre manufacturer's safety instructions. For safety reasons, split wheels must not be used (those made of two rims bolted together).
- Lifting the dumper for handling or inspection should be carried out using the points on the machine designed for this purpose, as indicated in this manual, and with strong enough gadget for this purpose. As the chassis is articulated, the frames must first be joined by the safety prop designed for this purpose.

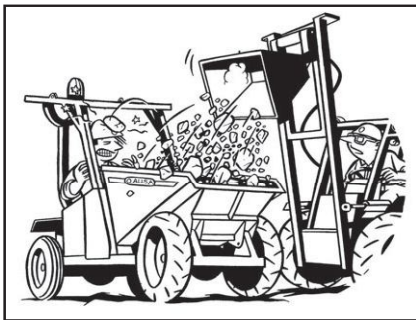

(fig. 1)



(fig. 2)

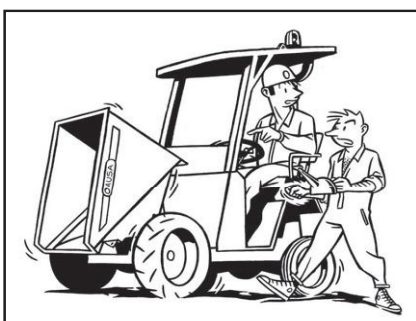

(fig. 3)



## Special safety messages

- If the dumper needs to be towed, use a tow bar whenever possible, or if none is available, a cable that is strong enough for the job. In either case, it should be fixed onto the point indicated by the manufacturer and the manoeuvre should be carried out at a speed not higher than 10 Km/h.  
When driving a towed dumper, pay attention to the position of your hands on the steering wheel, to ensure that an unexpected turn of the wheel does not cause you injury.
- Make sure that the towing dumper has a strong enough towing and braking capability to be able to perform this operation.
- If the dumper needs to be transported on a truck platform:
  - Ensure that only a minimum amount of fuel remains in the tank.
  - Apply the brakes to the dumper.
  - Apply chocks to the wheels and fix them to the truck bed.
  - Anchor the machine firmly to the truck bed using slings or other methods to prevent any kind of movement.
- When carrying out any repair work, make especially sure that the battery terminals are protected, so that they cannot accidentally be shorted out by a tool, part, etc.
- As the chassis is articulated (articulated frame steering), before undertaking any operation on the dumper, place the safety prop between the frames, in a way that the articulations are immobilized (**fig. 1**)
- Before carrying out any welding work on the dumper, remove the electric and electronic equipment in order to avoid possible damage to the installations.
- If the dumper to be towed is hydrostatically driven, before doing so, follow the instructions indicated in this manual for the disconnection of the drive shaft, therefore facilitating towing and eliminating any risk to the hydrostatic unit.
- When changing a tyre, make sure that it is fitted with the tread pattern facing the right way.
- Before carrying out any work on the engine cooling system, wait for the temperature of the coolant to drop enough for the coolant reservoir cap to be removed safely.
- In order to avoid allergic reactions and other hazards affecting the skin, replenishing of fuel or other fluids should be carried out wearing protective gloves.
- Be environmentally friendly. When changing oil, fluids, tyres, batteries, etc., take the used materials to the corresponding recycling centers. If you handle or scrap mufflers that contain mineral fiber based absorbent materials, protect your skin with the appropriate gloves and clothing and take the materials to approved disposal sites for this class of materials.  
Similarly, at the end of the useful life of this dumper, hand it to an authorized scrap center.
- Also, if concrete spills onto the road surface, remove it before it hardens.

### **ELECTROMAGNETIC COMPATIBILITY**

If the machine vehicle is used in areas where there are devices that are very sensitive to electromagnetic emissions, make sure that they will not be affected by this.



(fig. 1)

D100AHA / D100AHG  
D120AHA / D120AHG  
D150AHG



## Identification plates and decals

<b>AUSA</b>	TIPO-TYPE-TYP	
MADE IN SPAIN	MOTOR-MOTEUR-ENGINE	
	KW	
	ANO-ANNEE-YEAR	
BASTIDOR-CHASSIS-FRAME		
PESO - POIDS	VACIO-A VIDE- UNLOADED-LEER	kg
WEIGHT - GEWICHT	CARGADO-CHARGE-LOADED-BELASTET	kg
EJE DELANTERO	CARGA NOMINAL-CHARGE NOMINAL	kg
ESSIEU AVANT	NOMINAL LOAD-ZULASSIGE LAST	kg
FRONT AXLE		bar
VORNACHSE		
EJE POSTERIOR	CARGA NOMINAL-CHARGE NOMINAL	kg
ESSIEU ARRIERE	NOMINAL LOAD-ZULASSIGE LAST	kg
REAR AXLE		bar
HINTERACHSE		
CARGA REMOLCADA EN HORIZONTAL-CHARGE REMORQUEE EN PALIER - LOAD TOWED ON THE LEVEL - ZULASSIGE ANHÄNGELAST		
kg		
AUTOMOVILES UTILITARIOS, S.L.U. TEL. (9) 3474 73 11- FAX (9) 3474 12 85 E-mail: ausa@duma.com-Web: http://www.ause.com P.O.BOX. 194-08043 MANRESA (ESPAÑA) 01.90773.26		

<b>AUSA</b>	ESTRUCTURA PROTECCION PARA CASO DE VUELCO
	WALL OVER PROTECTING STRUCTURE (WOPS)
TECNOLOGIA	ES CONFORME A ISO 3471-34
	ES ACCORDING TO ISO 3471-34
APROBADA PARA MODELOS:	85/100/120/150 AHA/AHG
APPROVED FOR MODELS:	
MASA MAXIMA DE LA MAQUINA EN VACIO:	875 kg
MAXIMUM MASS OF THE UNLOADED MACHINE:	
AUTOMOVILES UTILITARIOS, S.A. - TEL. +34 93 874 73 11	



	MOTOR - MOTEUR - ENGINE
<b>SAE 20W/40</b>	
API-CD-CE-CF4	
43.01170.02	

	<b>DIESEL</b>
43.01356.00	

	DIN 51524
	VG 46
43.01352.20	

2,5 bar	36 P.S.I.
43.01358.00	

3 bar	43 P.S.I.
43.01359.00	

4,5 bar	66 P.S.I.
43.01360.00	

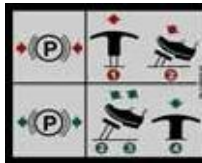

**CAUTION**

When leaving Dumper unattended, lower the bucket to transport position, place gear and directional control levers in neutral, apply the parking brake, stop the engine, remove ignition key

02.06773.03

**WARNING**

Do not attempt to use this machine without authorization and without knowing fully how the machine works

02.06777.00

**Danger!**

Keep clear of machine working area!

- D 100 AHA**
- D 100 AHG**
- D 120 AHA**
- D 120 AHG**
- D 150 AHG**

	LWA
<b>101</b>	
dB	
09.12011.00	

**WARNING**

Avoid touching fan. Serious injury can result.





## Specifications

### ■ Diesel engine

Kubota D1105 - EB, water cooled (with a mixed water/oil radiator) three cylinders, four stroke with electric starter.

**Power:** As per SAE J 1995; 16.8 Kw. / 22,8 at 2.700 rpm

### ■ Transmission

Hydrostatic system with variable flow pump and variable flow.

Set flow (REXROTH) or electrically controlled two speed (SAUER) hydrostatic motor.

**Work Pressure:** 345 bar

The drive direction (forward / reverse) is done using an electric switch on the lower part of the joystick handle on the right side of the seat.

When the direction is selected, the indication light in the form of an arrow pointing in the corresponding direction is lit.

### ■ Maximum Speed:

**Model D 100 AHA/AHG:** 15 km/h

**Model D 120 AHA / AHG:** 15 / 17 km/h

**Model D 150 AHG:** 14 km/h

### ■ Steering

"ORBITROL" Hydraulic system, driven by a hydraulic cylinder which controls the chassis articulation.

**Work Pressure:** 70 bar

### ■ Service and parking brake

Multiple disc oil filled sealed units with mechanical actuation.

### ■ Wheels

All four wheels are the same size.

### Wheel sizes and pressures

Model	Standard Wheel sizes	PRESSURE (bar) See dumper identification plate	Optional Wheel sizes	PRESSURE (bar) See dumper identification plate	Optional Wheel sizes (Narrow version)	PRESSURE (bar) See dumper identification plate
D 100 AHA	TT27 x 8.50-15" 8PR	2,5 ± 0,3	11.0/65-2 7.00-12	2,5 ± 0,3	6,5/80	4,5 ± 0,3
D 120 AHA	TT10.0/75-15.3 8PR	3 ± 0,3				
D 100 AHG	TT27 x 8.50 - 15"	2,5 ± 0,3	7.00-12	2,5 ± 0,3	-	-
D 120 AHG	TT10.0/75-15.3"	3 ± 0,3				
D 150 AHG	TT10.0/75-15.3"	3 ± 0,3	-	-	-	-

### ■ Operation temperature

From -15°C to 40°C.

D100AHA / D100AHG  
D120AHA / D120AHG  
D150AHG



## Specifications

### ■ Hydraulic Circuit

A 8 cc. gear pump coupled to the hydrostatic transmission pump.  
A two spools monoblock control block for skip actuation.

### Work Pressure:

**Model D 100 AHA/AHG:** 170 bar

**Model D120 AHA / AHG:** 170 bar

**Model D 150 AHG:** 210 bar

**Hydraulic oil tank:** 21,2 litres.

### ■ Electrical equipment

- Electrical starting motor of 1.0 Kw
- Battery 12V and 70Ah
- 12V/360W alternator with incorporated regulator
- Glow plugs
- Rotating beacon
- Horn

### ■ Unladen weight (with full tanks). See machine identification plate.

**Model D 100 AHA/AHG:** 1300 kg

**Model D 120 AHA/AHG:** 1375 kg

**Model D 150 AHG:** 1510 kg

### ■ Nominal load. See machine identification plate.

**Model D 100 AHA/AHG:** 1000 kg

**Model D 120 AHA/AHG:** 1200 kg

**Model D 150 AHG:** 1500 kg

### ■ Maximum Weight. See machine identification plate.

**Model D 100 AHA/AHG:** 2400 kg

**Model D 120 AHA/AHG:** 2675 kg

**Model D 150 AHG:** 3010 kg

### ■ Dumping system:

**AHA Models:** Hydraulic high-dump system

**AHG Models:** 180° turn hydraulic dump system

### ■ Maximum gradient (fully loaded)

**Model D 100 AHA/AHG:** 38%

**Model D 120 AHA/AHG:** 48%

**Model D 150 AHG:** 40%

### ■ Control panel

The controls, switches and warning lights are in the operator's front protection panel, as well as the switches and warning lights for optional lighting equipment.

### ■ ROPS Protector Arch

Built in accordance with ISO 3471 Standards.



## WARNING



The seat belt is an important part of this safety system and must always be fastened before operating the dumper. Failure to wear the seatbelt in the event of accidental overturning could result in serious injury or death by crushing caused by the dumper or the protector arch itself.



## Specifications

### ■ Outer turning radius

Model D 100 AHA/AHG: 3060 mm

Model D 120 AHA/AHG: 3060 mm

Model D 150 AHG: 3260 mm

### Skip capacities

	AHA		AHG		
	100	120	100	120	150
<b>Water</b>	345 l.	425 l.	325 l.	415 l.	520 l.
<b>Levelled</b>	395 l.	515 l.	390 l.	495 l.	626 l.
<b>Loaded</b>	505 l.	680 l.	510 l.	670 l.	835 l.

### ■ Standard equipment

- Anti vandal system
- Ergonomic seat with safety belt
- Joystick
- ROPS
- Rotating beacon
- Rear view mirror
- Reverse alarm

### ■ Optional Equipment

- Great comfort seat
- Homologated lightning equipment
- Towing hitch
- FOPS overhead guard
- Metal engine bonnet
- Back-up alarm on-off system selectable by the operator



D100AHA / D100AHG  
D120AHA / D120AHG  
D150AHG



## How to identify your dumper

### Important!

Please indicate model number, date of purchase and frame and serial number: when consulting AUSA or your dealer for any matter. This information can be found on the identification plate.

We recommend you make a record of these numbers in the spaces provided below for handy reference and keep it in your files.

Dumper model: .....

Date of purchase:.....

Frame number:.....

Engine number:.....

#### ■ The machine identification plate (fig. 1)

Is located on the front of the engine protector. It includes the EC trademark.

#### ■ The frame number (fig. 2)

Is marked on the front part, on the right side of the chassis.

#### ■ The engine number (fig. 3, 4)

Is marked on the left hand side, underneath the exhaust manifold, and on a label on the upper part of the valve cover.

#### ■ Identification plates of the main components.

Identification plates for all components not manufactured by AUSA, such as engines, pumps, etc. are attached to the components themselves, in the positions where they are originally fitted by the respective manufacturers.



(fig. 1)

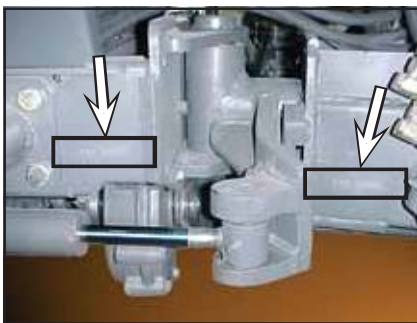

(fig. 2)

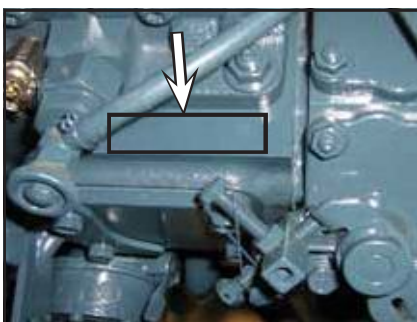

(fig. 3)



(fig. 4)



## Controls Instruments Equipment

■ The terms right, left, forward and back, when used in this manual are refer to these positions from the operator's seat looking forwards.

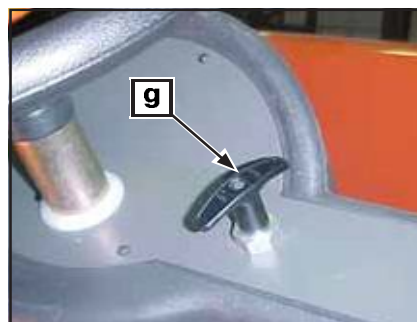

(fig. 2)

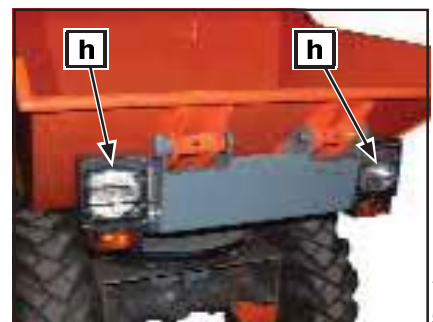

(fig. 3)

### ■ Identification of the components

- a- Protector arch
- b- Operator's seat with seatbelt
- c- Rotating beacon
- d- Skip
- e- Joystick
- f- Steering wheel
- g- Parking brake **(fig. 2)**
- h- Lightning (optional) **(fig. 3)**
- i- Rearview mirror

D100AHA / D100AHG  
D120AHA / D120AHG  
D150AHG



## Controls Instruments Equipment

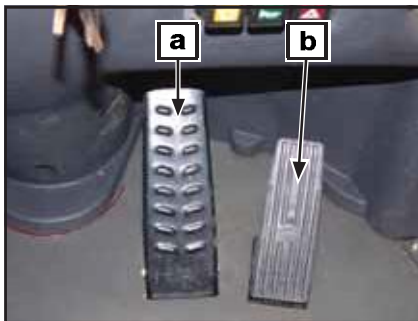

(fig. 1)



(fig. 2)

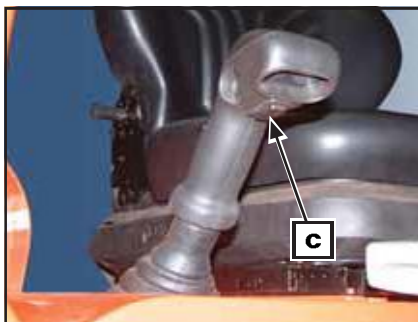

(fig. 3)



(fig. 4)

### ■ Pedals (fig. 1)

- a. Foot brake pedal
- b. Throttle pedal

### ■ Back-up alarm

This sounds when selecting reverse gear.



## WARNING



If the dumper is equipped with lighting, the back-up alarm is disconnected when the lights are switched on. However, the rear white reversing lights continue working.

An operator's choice on-off system can be assembled as an option (fig. 2)

### ■ Forward/reverse directional control (fig. 3)

The direction is controlled by using the electric switch (d) located on the bottom of the joystick handle. When the direction arrows are not lit, the driving FNR switch is in the stop (neutral) position. By pushing the front of the switch the machine will move forwards and by pushing the back of the switch, the machine will move reverse.

In each case the corresponding directional arrow will light up, green (forward) and red (reverse).



## WARNING



In order to prevent any breakage to the gearbox, do not make sudden changes in direction.



## WARNING



Before reversing the vehicle, ensure that there are no obstacles or persons behind you. Remain seated.

### ■ Speed control (only with SAUER hydrostatic motors) (fig. 4)

Using the electric switch (d), select the fast or slow speed.



## Controls Instruments Equipment

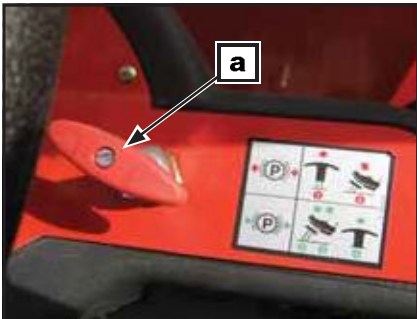

(fig. 1)

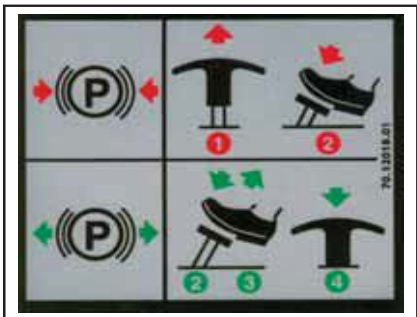

(fig. 2)

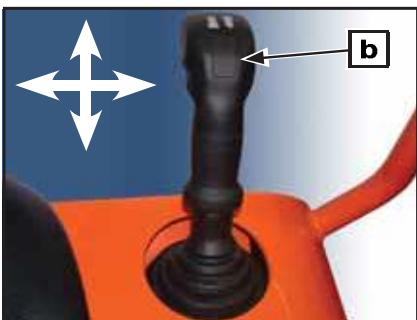

(fig. 3)

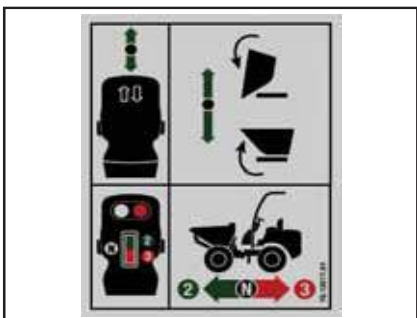

(fig. 4)

### ■ Parking brake (fig. 1, 2)

The parking brake is activated using the cable and lock mechanism located on the operator's front protection panel.

To apply the parking brake, fully apply the service brake with the pedal and then pull the lever **(a)**.

To remove the parking brake, apply the service brake again with the pedal whilst moving the lever **(a)** back to its resting position.

### ■ Emergency brake.

In the event of emergency use the parking brake.

### ■ Control for handling the skip (joystick) (fig. 3, 4, 5, 6)

The skip is moved by using the joystick. The joystick, located to the driver's right, controls the direction of the dumper movement and the operation of the cargo box.

Pushing the lever forwards **(b)** tips the skip for unloading and pulling it backwards moves the skip back to the resting position.

- **On AHA models**, pulling the joystick towards the driver will lift the cargo box horizontally, if it is pushed towards the right the cargo box will be lowered. **(fig. 4)**
- **On AHG models**, the cargo box turns towards the left or the right depending on whether the joystick is moved towards the driver or pushed to the right. **(fig. 5)**

Before rotating the skip, it must be raised enough to clear the locking device. When the skip is fully lowered, you should locate it into the "V" **(c)** much as possible in order to fit into the turn lock. **(fig. 6)**

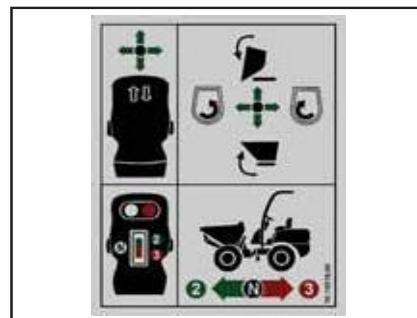

(fig. 5)

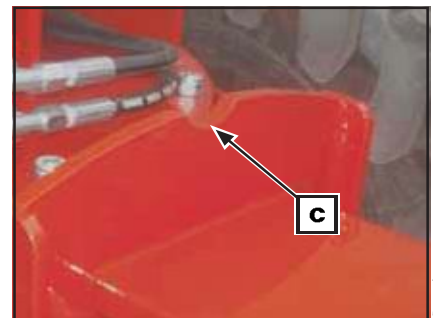

(fig. 6)

D100AHA / D100AHG  
D120AHA / D120AHG  
D150AHG



## Controls Instruments Equipment

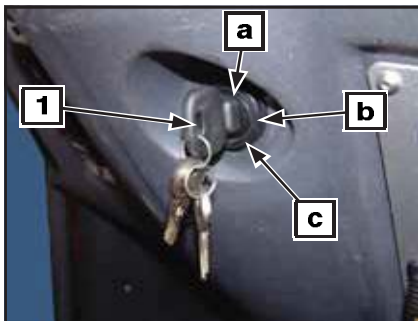

(fig. 1)

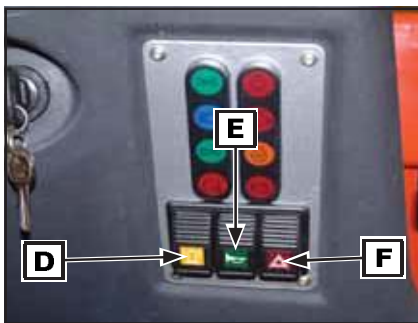

(fig. 2)

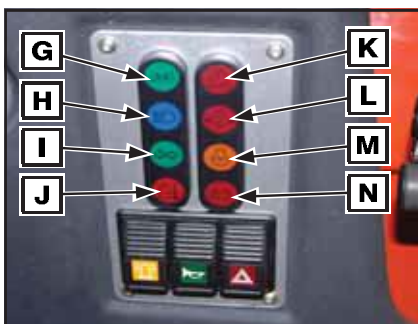

(fig. 3)

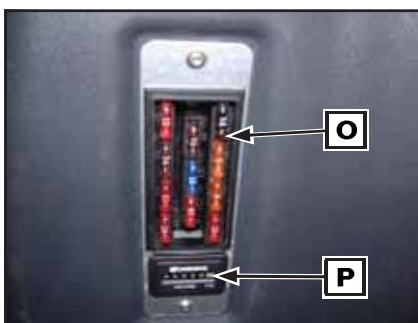

(fig. 4)

### ■ Control panel and controls

These are situated on the front operator protector and on the joystick.

### ■ Ignition switch (fig. 1)

This is located on the right side of the front protector.

- a. Stop
- b. Ignition / Preheat
- c. Start

### ■ Switches (fig. 2).

#### D- Rotating beacon

#### E- Horn

#### F- Hazard lights (only dumpers with lightning equipment)

These are located on the right side of the front protector. To turn on, press the button and it will light up. To turn off, press the button again.

### ■ Indicators and lamps.

These are located on the right side of the front protector. (fig. 3)

**G- Side lights lamp (only with lights option).** This lamp is lit when this type of lightning is selected.

**H- High beam lights lamp (only with lights option).** This lamp is lit when this type of lightning is selected.

**I- Turning indicators lamp (only with lights option).** This lamp blinks to signal a change in direction with the indicators.

**J- Engine temperature lamp.** If lit, this means that the engine temperature is too high. Stop immediately in order to determine the cause of the problem. This could be due to low level of coolant, dirt in the radiator, thermostat malfunction or a broken alternator belt or water pump.

**K- Air filter lamp.** Indicates when the air filter is dirty or clogged. The filter element must be cleaned or changed immediately.

**L- Engine oil pressure lamp.** When the ignition is activated it will light and will turn off when the engine is in operation. If the engine is functioning and the warning light is lit, the engine must be stopped immediately to prevent any damage. Check the oil level and add if necessary.

**M- Preheating lamp.** When this lamp is lit it indicates that the engine glow plugs are in operations and are heating the combustion chamber to a temperature which will enable the firing of the vaporised diesel fuel.

**N- Battery charge lamp.** With the ignition on, it will light when the alternator is not charging the battery and it will go out when the engine starts to run. If it remains lit, stop the engine and determine the cause.

### O- Fuse box. (fig. 4)

Located on the left side of the front protector. The fuse box contains 11 fuses. See the **WIRING DIAGRAM** in this Manual to identify the number and function of each fuse.

### P- Hourmeter. (fig. 4)

This is located underneath the fuse box. The hourmeter registers in hours the time during which the engine is in operation. This allows the dumper maintenance to take place at the appropriate periods.

See the **LUBRICATION AND MAINTENANCE CHART** section in this Manual.



## Controls Instruments Equipment

### ■ Multifunction switch (fig. 1, 2)

Located on the steering column.

**Turning indicators.** Moving the lever **(a)** from its neutral position towards the driver, the left indicator is selected and pushing the lever forwards, the right indicator is selected. When the turning indicators are selected, the lamp **(i)** (fig.3, previous page) blinks on the control panel.

**Side lights / low beam / high beam and headlights flash lights.** By turning the lever **(a)** to the first position the side lights are turned on. By turning it to the second position the low beam lights are turned on. By pushing the lever down the high beam is turned on. Pulling the lever upwards selects the headlight flash lights.

**Horn.** Activated by pressing the end of the multifunction switch.

### ■ Use of accessories and equipment.

In the case of the vehicle being equipped with accessories, before using them, carefully read the specific instructions manual for the accessory provided by its manufacturer and supplied together with the main dumper manual.

In the case of accessories and equipment being assembled on the basic chassis of the dumper by companies not connected to the manufacturer, all prescriptions and limitations of the dumper in relation to mass and dimensions, efficiency of the lighting system and adjustments thereto, along with the need for protection for additional systems must be taken into account in order to guarantee the safety of the dumper.



(fig. 1)



(fig. 2)

D100AHA / D100AHG  
D120AHA / D120AHG  
D150AHG



## Operating the dumper



(fig. 1)

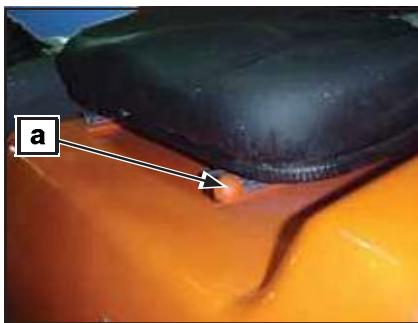

(fig. 2)

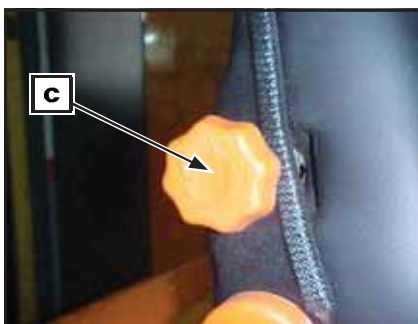

(fig. 3)



(fig. 4)

!
!

WARNING

Before each period of use of the dumper, check the correct operation of the steering, brakes, hydraulic controls, instruments, safety equipment and FNR Switch.  
A machine which functions correctly is more efficient and could prevent accidents.  
Carry out all necessary adjustments or repairs before operating the dumper.

### ■ Entering and exiting the operator's cab.

Do not grab and pull the steering wheel in order to enter the operator's cab, hold the handles provided for this purpose and always support your foot on the step in order to avoid slipping both when entering and exiting the cab.

### ■ Seat adjustment (fig. 1, 2)

Each day, before operating the dumper, adjust your seat to a position in which you feel comfortable. Turning lever (a) unlocks the seat which can then be moved forwards or backwards to the required position. The seat suspension can be adjusted between 60 and 120 kg depending on the operator's weight, with 24 turns of the lever (b). The seats are normally set for a person weighing 90 kg.

Turning knob (c) adjusts the seat's tilting backrest. Turning it to the right tilts the backrest backwards, and turning it to the left tilts the backrest forwards. Ensure that you fasten your seatbelt.

### ■ Seatbelt (fig. 3, 4, 5)

To fasten the seatbelt, insert the anchor point (d) into the buckle (e) until you hear the locking "click".

To unfasten the seatbelts, press button (f). The seat belt adapts the body of the passenger using it, giving them freedom of movement but adjusting the belt to the physical constitution of the driver.

If the machine is parked on a steep slope, the retracting roller could become locked; this is normal. Additionally the retracting roller blocks the belt every time the belt is suddenly pulled or in case of sharp braking, collisions or turning operations at high speed.

### ■ Checks

With the engine on and the dumper stopped, carry out the checks and tests indicated in the **PRE-OPERATION CHECK** section of this manual.

### ■ Loading the dumper

When the dumper is loaded, respect the maximum allowed load.  
See the **SPECIFICATIONS** section in this manual

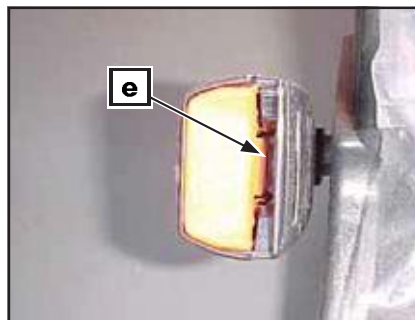

(fig. 5)

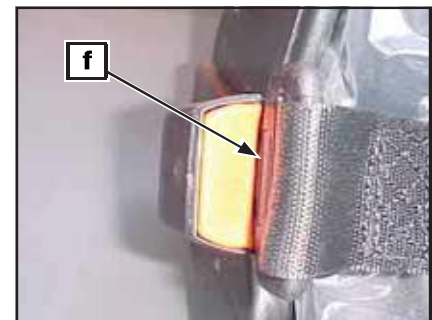

(fig. 6)



## Operating the dumper

### ■ **Load capacity (see dumper identification plate)**

The nominal load is the load which the dumper can safely transport it is determined by the weight of the load.

The use of attachments may reduce the load capacity.

The condition of the ground and the load method may affect safety conditions.

An overload on the skip makes the dumper unstable, hard to handle and may cause the tipping over of the vehicle or breakage of some components.



## WARNING



Handling, stability and braking distance are affected when the dumper is loaded. Correct loading and weight distribution are important. Never, overload, tow or pull a load improperly. Always ensure that the load is supported and adequately distributed before operating the dumper. Drive at slow speed and in accordance with the ground conditions when transporting a load or towing a trailer.

Remember that a greater braking distance is required. Always place the load as low as possible in order to reduce the effects of a high centre of gravity. Failure to follow these recommendations could cause changes to the handling of the dumper with the possibility of an accident occurring, which could cause serious injury or even death to the operator.

### ■ **The relation between the dumper and the load is conditioned by changes in:**

- The use of attachments
- Changes in the dumper movement and type of terrain in which the vehicle moves
- Smoothness and stability must be maintained whilst these factors constantly vary during dumper operations.

This requires a careful judgment on the part of the operator.



D100AHA / D100AHG  
D120AHA / D120AHG  
D150AHG



## Operating the dumper

### ■ Start-up and stop

#### Start-up (fig. 1)

For safety reasons when starting the dumper, the operator must be seated and with the seatbelt fastened, the hand brake must be applied and a check that the FNR switch are in the neutral position must be carried out.

Insert the key into the ignition switch and turn it to position **(b)** until the preheat lamp turns off, press the throttle pedal a 1/4 of the way and turn the key to position **(c)** until the engine starts. Do not keep this position for more than 15 seconds. If the engine does not start repeat the previous operations. Wait for 30 seconds between each try.

### NOTE

This machine has a starter lock. Take into account that the electric switch for the FNR switch must be in the neutral position.

### CAUTION

In cold temperatures, slowly increase the engine revolutions to achieve good lubrication of the engine.

### Emergency start

If the engine cannot start due to a flat battery, another 12V booster battery can be used together with the corresponding jump leads to connect the two batteries. If you use the battery of another machine or dumper, avoid the two machines touching.

Apply the dumper's parking brake.

- Open the dumper engine bonnet.
- Connect the (+) positive terminal of the battery with the (+) terminal of the dumper and with the other cable connect the (-) negative terminal with the (-) of the dumper.
- Start the dumper in the normal way.
- Disconnect the cables from the terminals, first the (+) positive terminals and then the (-) negative terminals.

### ■ Parking the dumper and stopping the engine.

Whenever the dumper is parked, either at the end of the day or in order to carry out any maintenance work, it should be parked on level ground. Apply the dumper's parking brake. Keep the engine in idle for 1 minute, if the dumper has been working at full load. Then turn the ignition key to position **(a)** to stop the engine. Chocking the wheels with suitable blocks is also recommended. Remove the key from the ignition and take it with you. Never leave the key in the parked dumper.

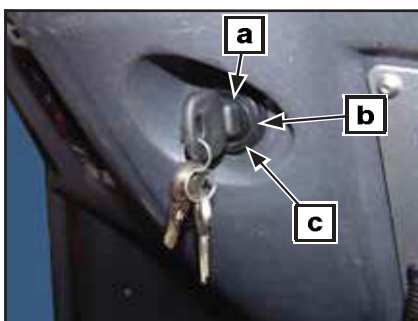

(fig. 1)



## Operating the dumper

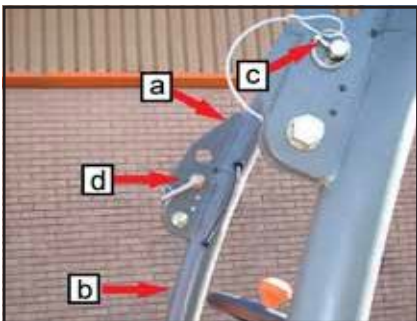

(fig. 1)



(fig. 2)



(fig. 3)



(fig. 4)

### ■ Procedure for folding the ROPS protector arch (fig. 1, 2, 3, 4)

The ROPS folding protector arch is comprised of two sections (a) and (b) and can pivot to approximately half of its length allowing it to be folded down towards the front of the machine and thereby reduce the full height of the machine for transport purposes.

#### Transport position

	<b>WARNING</b>	
Do not work with the machine if the ROPS protector arch is in the Transport position.		

To place the ROPS protector arch in this position follow the instructions below:

- 1- Remove the two locks (c) from the bolts (d) located on each side of the ROPS protector arch.
- 2- Remove the bolts (d).
- 3- Carefully fold the upper part of the ROPS protector arch (a) forwards into its Transport position.
- 4- Once folded into position (fig. 4), insert the bolts (d) and then insert the locks (c).

#### Working position

To place the ROPS protector arch in this position follow the instructions in the reverse order.

	<b>WARNING</b>	
Carefully ensure you position your feet on the machine or on the floor in a stable position to ensure that you do not lose your balance whilst folding back the ROPS protector arch. Similarly, take care to not place your hands around the protector arch fold area (fig. 5) as this could cause serious injury.		

(fig. 5)



D100AHA / D100AHG  
D120AHA / D120AHG  
D150AHG



## Break in period

- **Engine**

The engine in this dumper requires a break in period of 50 hours before operating the vehicle at full load.

### CAUTION

This dumper has a 4-stroke engine. Oil must be added to the engine base only. During this period, maximum throttle should not exceed 3/4 of the pedal movement. However, brief full acceleration and speed variations contribute to a good break in. Continued wide open throttle accelerations, prolonged cruising speeds and engine overheating are detrimental during the break in period.

- **First inspection (50 hours)**

As with any precision part of a mechanical element, we suggest that after the first 50 hours or 30 days from purchase, whichever is reached first, the dumper is inspected by an authorised AUSA dealer. This inspection will give you the opportunity to discuss the unanswered questions you may have encountered during the first hours of operations.



## Pre-operation check



### WARNING



The pre-operation check is very important prior to operating the dumper. Always check the proper operation of critical controls, safety systems before starting. Failure to carry out these operations as specified could cause severe harm or even death.

- Check tyre pressure and condition.
- Familiarize yourself with the controls and ensure that they function correctly.
- Verify that the steering operates freely.
- Press the throttle pedal various times to ensure it operates freely. It must return to the original position when released.
- Press the brake pedal to ensure that the brakes function correctly. The pedal must return to the original position when released.
- Ensure that the direction control switch (FNR) operates correctly.
- Check fuel, engine oil, hydraulic oil, coolant and brake fluid levels.
- Check for oil leaks on the engine, in the transmission components or in the hydraulic circuit.
- Clean the lights and the lamps (if fitted).
- Ensure that the engine protector is correctly covered.
- Ensure that the seatbelt is correctly secured. Before starting the day, carefully inspect this device with special attention to:
  - Cuts or threading on the belt.
  - Wear or damage to anchor points
  - Poor functioning of the seat belt buckle.
  - Loose threads or poor stitching
- If transporting cargo, respect the load capacity. Ensure that the cargo is properly distributed.
- Review the engine parts while it is off. Check fixings.
- Check that the ignition switch, the headlights, the turning indicators, taillights and backup alarm and lights for reverse are functioning correctly.
- Start the engine and drive forward slowly a short distance and press the brake pedal to check the brakes.

**Correct any problem you may have found before operating the dumper .**  
**Consult an authorised AUSA dealer if necessary.**

D100AHA / D100AHG  
D120AHA / D120AHG  
D150AHG



## Transporting the dumper

### ■ Securing / immobilising the dumper on the truck bed (fig. 1)

When transporting the dumper on a truck bed or low loader, carefully follow the advice given in the following chart:

! WARNING !
<p>Before raising the dumper onto a trailer or truck bed, make certain that the ramp is strong enough to support the weight of the dumper and that the truck bed surface is free from debris, oil, grease or ice.</p> <ul style="list-style-type: none"> <li>· Do not transport the dumper with the fuel tank full.</li> <li>· Make certain your seatbelt is properly fastened.</li> <li>· Move the dumper slowly and carefully up or down the loading ramps.</li> <li>· Apply the dumper's parking brake.</li> <li>· Stop the engine and remove the key from the ignition switch.</li> <li>· Apply chocks to the front and rear wheels.</li> <li>· Firmly secure the dumper to the truck bed or low loader with chains, cables or slings at the points provided to prevent any movement.</li> <li>· Take into account that the securing systems should be adequate and sufficiently resistant for this purpose.</li> </ul>

### ■ Loading the dumper with a crane (fig. 2, 3)

When the dumper is loaded onto a truck using a crane and a cable or sling:

- Before moving, immobilise both parts of the sling using the joining prop provided for this purpose (a).
- Hook the cable or sling on the points provided for this purpose on the machine.
- Always carry out this operation with the machine unloaded.
- Before hoisting check that the cable or sling is firmly hooked and that both the crane and the cable or sling has sufficient capacity to lift the load.
- During hoisting do not allow any person to be on the truck or any spectators within a 5m radius.
- Always undertake this operation on flat and horizontal ground.
- Use guide ropes or other systems to avoid the machine pivoting or turning.

Also take into account the following recommendations.

- The slings must be long enough to form an angle wider than 45° with the horizontal.
- Always elevate the machine in the most horizontal position possible.



(fig. 1)

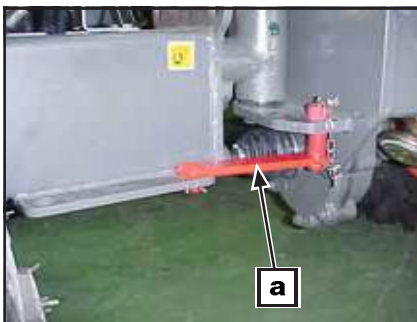

(fig. 2)



(fig. 3)



## Transporting the dumper

### ■ Towing the dumper (fig. 1, 2)

Towing dumper is only advisable in cases of breakdown when there is no other alternative. Whenever possible, it is recommended to repair the vehicle where it is halted. Otherwise, the towing must only be done slowly and over short distances.

Release the parking brake.

Before towing the dumper, the central screws of the hydrostatic pump's maximum pressure valves must be fully tightened (but not overtight); to do so, loosen the counter-nuts (**fig. 1**).

Once the vehicle is repaired, loosen the central screws on the maximum pressure valves of the hydrostatic pump again and re-tighten the counter-nuts.

Drive slowly and carefully without exceeding 10 km/h (6 Mph), complying with the country regulations relating to the towing of an off-road vehicle on roads and highways. The dumper must be towed using a solid towbar to avoid any sideways oscillation, and always with the chassis fixed rigid with the safety prop included (**fig. 2**).



## WARNING



Do not tow this dumper behind a car or other vehicle.



(fig. 1)

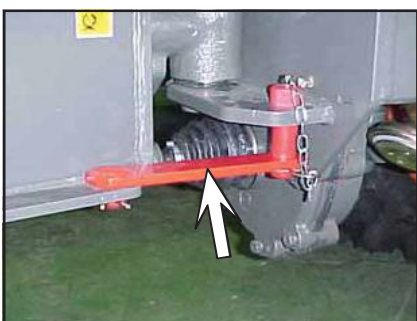

(fig. 2)



D100AHA / D100AHG  
D120AHA / D120AHG  
D150AHG



## Liquids and lubricants

This section specifies the recommended liquids and lubricants. See PERIODIC MAINTENANCE OPERATIONS in the Manual for the procedures to follow for changing and checking the levels of fluids.				
LIQUIDS or LUBRICANTS	SPECIFICATION	OBSERVATIONS	AUSA REF.	CAPACITY
<b>FUEL</b>	Diesel class A as per directive 98/70CEE amended by directive 2003/17 or in regulation EN 590. Sulphur content of less than 0.5% ASTM D975 GRADES 1D and 2D	See <b>FUEL</b> in this section		23 Litres
<b>ENGINE OIL</b>	Use oil for four stroke engines which meets requirements MIL-L-2104C / API CD or above.	See <b>KUBOTA ENGINE OIL</b> in this section	461.00099.00	5,1 Litres
<b>COOLANT</b>	Always use ethylene-glycol antifreeze containing corrosion inhibitors especially for internal combustion aluminium engines. 30% glycol and 70% distilled water in a standard machine.	See <b>COOLANT</b> in this section	45.00075.00	5 Litres
<b>HYDRAULIC CIRCUIT</b>	Hydraulic oil ISO Grade VG-46 in accordance with ISO 6743/4 HV DIN 51524 Part 3 - class HVLPL	See <b>HYDRAULIC CIRCUIT</b> in this section	461.00099.06	21,2 Litres
<b>FRONT AXLE OIL D 100 AHA/ AHG</b>	Transmission oil SAE 90 as per API GL5 / MIL-L-2105 B	See <b>AXLES AND TRANSFER BOX OIL</b> in this section	461.00004.01	3 Litres
<b>FRONT AXLE OIL D 120 AHA/ AHG D150AHG</b>				3.2 Litres
<b>REAR AXLE OIL D 100 AHA/ AHG</b>	Transmission oil SAE 90 as per API GL5 / MIL-L-2105 B	See <b>AXLES AND TRANSFER BOX OIL</b> in this section	461.00004.01	3 Litres
<b>REAR AXLE OIL D 120 AHA/ AHG D150AHG</b>				3.2 Litres
<b>BATTERY ELECTROLYTE</b>	Distilled water	See <b>BATTERY ELECTROLYTE</b> in this section		
<b>GREASING POINTS</b>	Calcium soap grease NLGI-3 consistency	See <b>GREASING POINTS</b> in this manual	461.00009.00	



D100AHA / D100AHG  
D120AHA / D120AHG  
D150AHG

## Liquids and lubricants

### ■ Fuel

Use automotive clean diesel (class A), which preferably meets 98/70/CEE standard amended by standard 2003/17 or the equivalent EN 590 standard. In Spain RD 1728/1999 applies. For the USA market, it must meet Grades 1D and 2D of the ASTM D975 standard, in supplies which do not meet these standards, the sulphur content should never exceed 0.5% mass.

In principal, the use of REM type bio diesel or similar is not recommended. In case of use, the proportion used should not exceed 5% of the fuel mix.

### ■ KUBOTA engine oil

Use oil for four stroke engines which meets requirements MIL-L-2104C / API CD or above. Always check the API quality on the oil container label to ensure that it is the required quality.

Your dumper leaves the factory with SAE 20W40 oil viscosity. However, depending on the climate, consult the chart to select the most appropriate viscosity (**fig. 1**).

If oils of different brand names are used, ensure that you completely empty the crankcase before adding the new oil.

AUSA recommends REPSOL AUSA EFFICIENT for Diesel engines p/n 461.00099.00

### ■ Coolant

Always use ethylene-glycol antifreeze containing corrosion inhibitors especially for internal combustion aluminium engines. The cooling system must be filled with distilled water and an antifreeze solution (60% water, 40% antifreeze in standard machines for temperatures from -17°C to 127°C)

(50% water, 50% antifreeze for temperatures from -35°C to 145°C).

### ■ Hydraulic Circuit

- VG32 for ambient temperatures normally lower than 10°C.
- VG46 for ambient temperatures between 10°C and 40°C.
- VG68 for ambient temperatures normally higher than 40°C.

### ■ Axles and transfer box oil

Transmission oil SAE 90 as per API GL5 / MIL-L-2105 B

### ■ Battery electrolyte

This dumper is equipped with a battery that requires maintenance. Add distilled water if necessary.

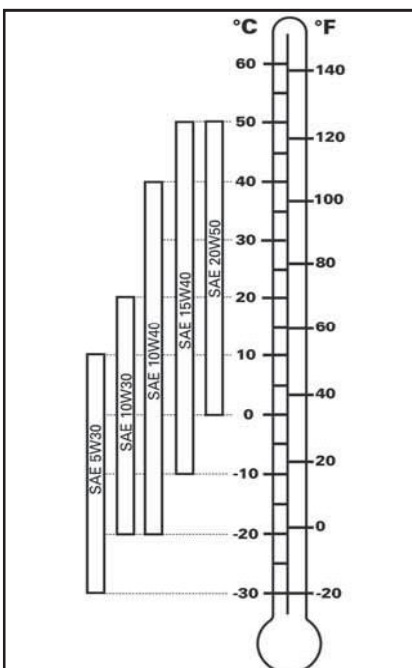

(fig. 1)



D100AHA / D100AHG  
D120AHA / D120AHG  
D150AHG



## Special procedures

### 1.- Engine Overheat

If the engine overheats and the temperature indicator on the instrument panel is lit, try the following:

Check and clean the radiator fins. See the **PERIODIC MAINTENANCE OPERATIONS** section of this manual.

	<b>WARNING</b>	
<p>The radiator can get very hot, wear gloves before touching the radiator. Reduce the dumper speed but try to keep the vehicle moving to supply air to the radiator.</p> <p>If the engine is still overheating after approximately 1 minute, stop the dumper and place the FNR switch in the neutral position, apply the parking brake and stop the engine.</p> <p>Allow the engine to cool down. Check the coolant level and refill if necessary. If the engine continues to overheat, see an authorised AUSA dealer as soon as possible.</p>		

### 2.- Post-operation care

When the dumper is used in salt water areas (beach areas, etc.), rinse with clean water to preserve the dumper and its components.

Lubrication of metallic parts is highly recommended.

This must be performed at the end of each operation day. When operating the dumper in muddy conditions, rinsing the dumper is recommended to preserve the dumper and its components.

	<b>WARNING</b>	
<p>Never use water at high pressure to clean the dumper. <b>ONLY USE LOW PRESSURE WATER.</b> High pressure water can cause electrical and mechanical damage.</p>		



## Special procedures

### 3.- Overturning

In the event that the dumper overturns: it is important that the driver avoids being trapped between the machine and the ground. To prevent this we recommend:

- Try to remain within the operator cab.
- Grasp the steering wheel firmly.
- Push feet firmly against the floor plate of the cab.
- Try to keep as far away from the point of impact as possible.

When the dumper is overturned or stays tilted on one side, replace the vehicle in its normal operating position (on all four wheels).



### WARNING



DO NOT TRY TO START UP THE DUMPER without speaking first with an AUSA dealer.

- Remove the glow plugs.
- Turn the key in the ignition to the position **(C)** (fig. 1) . Keep the key in this position until the oil has left the combustion chambers.



### WARNING



The oil will leave the combustion chambers at a high pressure and could cause injury.

- Replace the glow plugs.
- Check the engine oil level and refill if necessary.

If the pressure lamp remains lit after starting the engine, immediately stop the engine to avoid internal damage and consult an authorised AUSA dealer to determine the cause.

### 4.- Dumper immersion

Should the dumper become submerged, it will be necessary to take it to an authorised AUSA dealer as soon as possible.



### WARNING



DO NOT START THE ENGINE. Immersion of the dumper can cause serious damage if the correct re-start procedures are not followed before starting the engine.

Have an authorised AUSA dealer completely inspect the fuel system as specified in the **LUBRICATION AND MAINTENANCE CHART**.

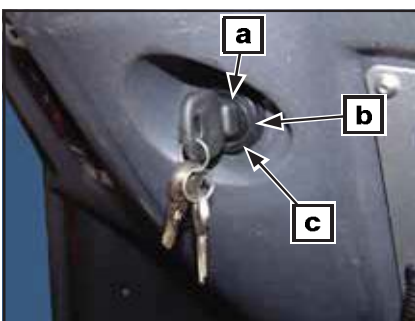

(fig. 1)

### 5.- Storage and pre-season preparation

When a dumper is not in use for more than one month, proper storage is necessary. Equally, after being store for a long period of time, consult an authorised AUSA dealer for the correct start up procedure. When using the dumper after storage, preparation is required.

D100AHA / D100AHG  
D120AHA / D120AHG  
D150AHG



## Periodic maintenance operations

■ **In maintenance operations only use original A USA spare parts. This is the only way to guarantee that your dumper will remain as technically efficient as when it was purchased.**

■ In this dumper as with any other, there are parts and system which are subject to wear and misalignment, which may affect reliability and driver safety, the environment and the area, for example exhaust emissions, etc.... Necessary maintenance must be carried out periodically to ensure that the machine is kept in a condition similar to when it left the factory.

In accordance with Work Group Directives, inspections of these systems must be carried out periodically and the results recorded on the forms provided by the Work Authorities of each country. (89/655/CEE and RD1215/97).

Unless otherwise specified, do not start the engine during maintenance operations.

Although certain repairs may require the engine to be running, all repairs and maintenance operations must be performed with the dumper unloaded, the direction control switch in neutral and with the wheels blocked to keep the dumper from moving during servicing.

Disconnect the battery with the disconnecter (**fig. 1**) before performing any operation on the electrical system. The disconnecter is located on the negative (-) terminal of the battery. Never use a flame to check fluid levels.

■ **Be environmentally friendly.**

When changing oils or other fluids, use an appropriate container to collect the fluid and ensure that you are not harming the environment during the operations and take all replaced materials (batteries, coolant, tyres, etc.) to the appropriate recycling centres.

In cases of leaks of substances which could be harmful to people or the environment, urgently take the necessary actions to reduce the impact, e.g. in oil leaks, plug the leak, place a container to collect the oil, spread absorbent material or pick up and remove the contaminated ground if necessary.

■ **Washing the dumper**

During the washing process, care must be taken to avoid aiming the pressurised water jet at the air intake (air filter), battery, instrument panel, alternator and other electrical equipment since this can damage the components.

■ **Roadside breakdown**

In the case of a breakdown when driving on a road, you must use the warning triangles. The triangles are offered as optional equipment.



(fig. 1)



## Periodic maintenance operations

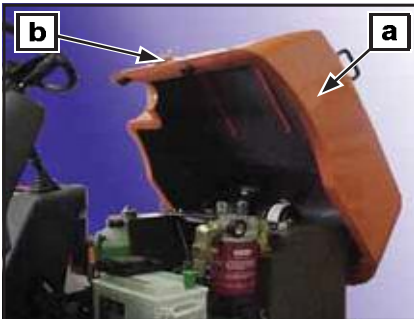

(fig. 1)

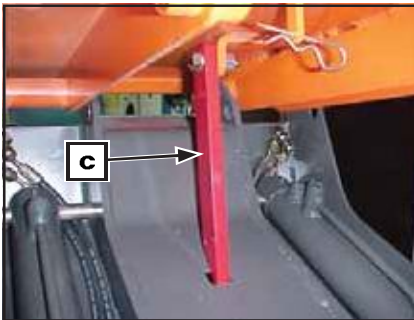

(fig. 2)

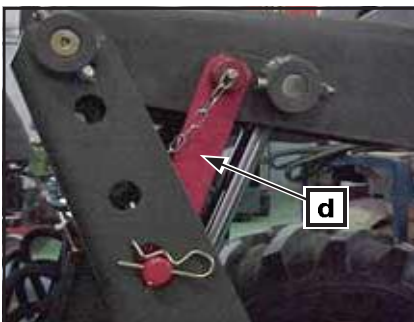

(fig. 3)

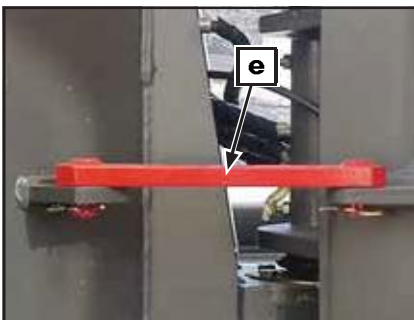

(fig. 4)

### ■ Access for maintenance (fig. 1, 2)

The engine, the transmission and the filters are located underneath the engine bonnet (a). To access them, lift the cover.

- a. Engine cover
- b. Engine cover lock

There are gas springs to keep the cover in the lifted position.

### ■ Safety prop to avoid the descent of the skip (fig. 2)

At the bottom of the cargo box there is a lock (c) to stop the cargo box from lowering during maintenance operations. This ensures that you work on the machine in complete safety.

- c. Safety prop to avoid the descent of the skip

### ■ Safety prop to avoid the descent of the skip (AHA) (fig. 3)

The lock (d) to prevent any sudden descent of the cargo box lifting system during maintenance operations is the same joining beam used to immobilise the chassis which should be used as shown in (fig. 3).

- d. Cargo box lifting lock (AHA)

### ■ Chassis articulation safety prop (fig. 4)

Before carrying out any intervention which requires you to be located between the two parts of the chassis, immobilise the articulation with the safety prop provided for this purpose.

- e. Chassis articulation safety prop



## WARNING



Should removal of a fixing device (brackets, cable ties, etc) be required to carry out disassembly / assembly, always replace with a new one.  
Initial maintenance is very important and must not be neglected. See the **LUBRICATION AND MAINTENANCE CHART** section in this Manual

The maintenance of some of the components can be carried out by the clients if they wish to do so. Other operations must be carried out by an authorised AUSA dealer. Consult the **LUBRICATION AND MAINTENANCE CHART** in this Manual.

D100AHA / D100AHG  
D120AHA / D120AHG  
D150AHG



## Periodic maintenance operations

### 1.- Engine

For operation instruction, list of spare parts and general maintenance consult the engine manual or the **LUBRICATION AND MAINTENANCE CHART**.

#### ■ Alternator belt

Periodically check the tension in the alternator belt. Also check for cracks or other damage. Contact an AUSA dealer for replacement of the alternator belt.

### 2.- Fuel system

## CAUTION

Never mix oil with fuel. This vehicle has a 4-stroke engine. Oil must be added to the engine base only.  
Use automotive clean diesel (class A), which preferably meets 98/70/CEE standard amended by standard 2003/17 or the equivalent EN 590 standard. In Spain RD 1728/1999 applies.  
For the USA market, it must meet Grades 1D and 2D of the ASTM D975 standard, in supplies which do not meet these standards, the sulphur content should never exceed 0.5% mass. In principal, the use of REM type bio diesel or similar is not recommended. In case of use, the proportion used should not exceed 5% of the fuel mix.

#### ■ Fuel level (fig. 1)

The fuel tank is located on the right side of the engine compartment. There is an indicator dial which shows the approximate amount of fuel in the tank.

- a. Fuel level indicator dial.
- b. Fuel filling cap.

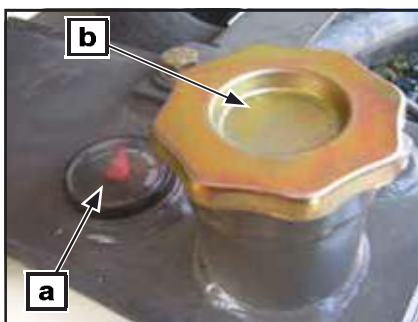

(fig. 1)

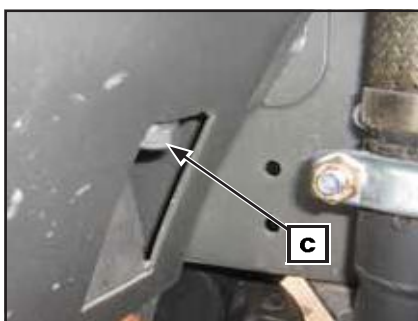

(fig. 2)

## WARNING

Always stop the engine before refuelling. Open the cap slowly. If you notice internal pressure (whistling sound heard when removing the fuel tank cap) the dumper must be inspected and/or repaired before further operation. Fuel is flammable and explosive under certain conditions. Never use a flame to check fuel levels. Never smoke, light a flame or sparks in the vicinity of the fuel tank. Always work in well ventilated areas. Never top up the fuel tank before placing the vehicle in a hot area. When temperature increases, fuel expands. If the fuel tank is completely full it may overflow. Always clean any fuel or oil spillage from the dumper.

#### ■ Draining the fuel tank.

##### c. Oil drainage hose (fig. 2)

Draining fuel is done via the plug situated on the lower part of the tank.

- Clean the area around the fuel drain plug.
- Place a container underneath the fuel drain plug.
- Unscrew the plug.
- Change the seal in the fuel drain plug. Clean the tank seal area and the oil drainage plug and replace it. Ensure that there are no leaks from the fuel drain plug.

## WARNING

Clean any fuel spillage.



## Periodic maintenance operations

### ■ Changing the fuel pre-filter (fig. 1)

#### NOTE

Always replace this component, under no circumstances should you attempt to clean it.  
Access the engine compartment

- a. Pre-filter
- b. Brackets

Remove the fixing brackets and the filter. Ensure that the new filter is located in the correct direction as indicated by the arrow marked on the filter body.

### ■ Changing the fuel filter

Unscrew the fuel filter located on the right side of the engine compartment.

#### c. Fuel filter (fig. 2)

Clean the base and cover the seal of the new filter with clean oil. Screw in the filter element once again and tighten, do not use mechanical tools.



#### WARNING



- Clean any oil spill on the engine.
- Start the engine and leave running idle for a few minutes.
- Ensure that there are no leaks from the fuel filter area.
- Stop the engine.
- Dispose of the filter cartridge and the dirty fuel in authorised centres.
- Take particular care when tightening the fuel filter because if it is incorrectly tightened, it could cause the fuel system to take in air causing engine failure.

### ■ Fuel system bleed.

If the fuel system has taken in air, bleeding is not necessary as it has a system for expelling air from the circuit.

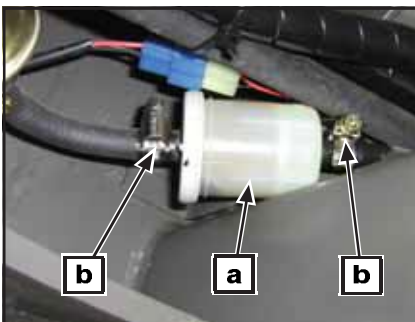

(fig. 1)



(fig. 2)

D100AHA / D100AHG  
D120AHA / D120AHG  
D150AHG



## Periodic maintenance operations

### 3.- Engine oil

#### ■ Engine oil level (fig. 1, 2, 3)

Frequently check the level and refill if necessary. Do not exceed the maximum level. Operating the engine with an inappropriate oil level could severely damage the engine. Clean any spills.

With the dumper on a level surface and the engine stopped and cold, check the oil level in the following way.

#### a. Dipstick

- Pull the oil level dipstick **(a)**, remove it from its housing and clean it with a clean cloth **(fig. 1)**.
- Place the dipstick in its housing.
- Remove it once again from the housing and check the oil level. It must be up to or equal to the upper level mark. **(fig. 2)**

#### b. Full

#### c. Add

#### d. Operating range

- Add oil up to the upper level mark if required.
- To add oil, remove the oil level dipstick. Place a funnel in the oil filling hole located on the top of the engine.

#### e. Filling hole

- Do not exceed the maximum level.
- Properly cover the oil filling hole and correctly store the oil level dipstick.

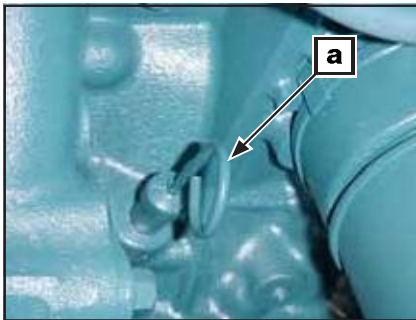

(fig. 1)

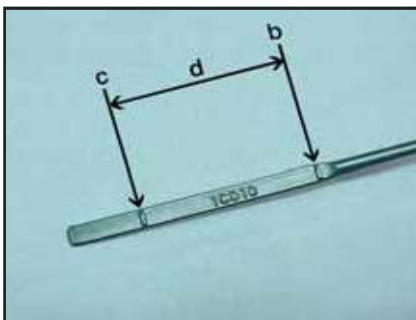

(fig. 2)

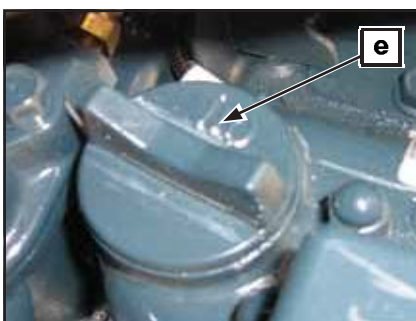

(fig. 3)



## Periodic maintenance operations

### ■ Changing the oil and the oil filter (fig. 1, 2)

Changing the oil and the oil filter should be carried out at the intervals indicated in the **LUBRICATION AND MAINTENANCE CHART** in this Manual.



### WARNING



The first engine oil change should be carried out at the 50 hour service. Initial maintenance is very important and must not be neglected

#### f. Oil drainage plug

- Oil changes should be carried out when the oil is warm.
- Secure the dumper on a level surface.
- Remove the dipstick.
- Clean the area around the oil drainage plug.
- Place a container underneath the oil drainage plug.
- Unscrew the oil drainage plug.



### WARNING



The engine oil could be very hot. In order to prevent burns, does not unscrew the filter if the engine is hot. Wait until the engine oil is warm. Allow the oil to drain for a while. Unscrew the oil filter cartridge located on the left side and remove it from its support.

#### g. Oil filter cartridge

Clean the base and cover the seal of the new filter element with clean oil. Screw in the filter element once again and tighten by hand, do not use mechanical tools.



### WARNING



- Clean any oil spill on the engine.
- Change the seal in the oil drainage plug.
- Clean the engine joint area and the oil drainage cap and replace the cap.
- Refill the engine as per the recommended oil level.
- See the **LIQUIDS AND LUBRICANTS** section of the Manual for capacities.
- Start the engine and leave running idle for a few minutes.
- Ensure that there are no leaks in any of the oil filter areas and on the oil drainage plug.
- Stop the engine.
- Wait a few moments to allow the oil to flow towards the engine crankcase and then check the oil level.
- Refill if necessary.
- Dispose of the oil in appropriately authorised centres

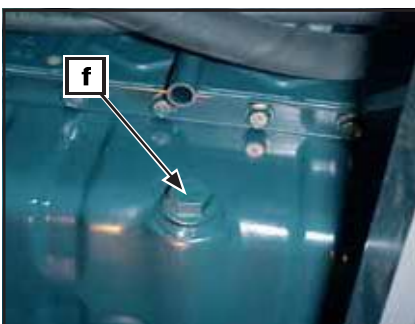

(fig. 1)

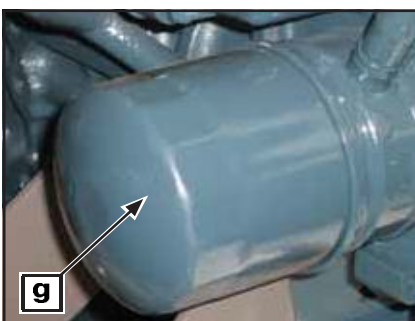

(fig. 2)



D100AHA / D100AHG  
D120AHA / D120AHG  
D150AHG



## Periodic maintenance operations

### 4.- Engine cooling system

Consult the **LIQUIDS AND LUBRICANTS** section of this Manual for the specifications of the coolant liquid to be used.



## WARNING



Never remove the reservoir cap if the engine is hot. Wait until the engine is cold. Wait for approximately 20 minutes.

#### ■ Coolant level. (fig. 1)

Check via the reservoir.

##### a. Reservoir

Lift the cover of the engine compartment. With the vehicle on a level surface, the liquid must be between the MIN. and MAX. levels marked on the reservoir.

## NOTE

When checking the level at a temperature lower than 20°C (68°F), the level may be below the MIN mark.

Add coolant up to MAX. mark if required. Never exceed the maximum level. Use a funnel to avoid spills.

Place and tighten the filling cap correctly and close the cover

## NOTE

A cooling system which requires coolant frequently indicates that there are leaks or engine problems. See an authorised AUSA dealer.

#### ■ Changing the coolant (fig. 2, 3)

- b. Cylinder block drainage tap
- c. Lower radiator hose

This change should be carried out every 500 hours or when the circuit is emptied for repair. To do so the following operations are carried out:

- Open the cylinder block drainage tap, located on the left side of the engine, to drain it.
- Disconnect the lower radiator hose in order to empty the radiator at this point.
- Before filling the circuit the engine drainage tap must be closed and the hose must be connected again.
- Refilling is carried out via the reservoir.
- Start the engine and wait until the thermostat is open.
- Then with the engine cold, check the level in the reservoir.

Check the replacement schedule in the **LUBRICATION AND MAINTENANCE CHART** or replace when the circuit is emptied for repairs.



(fig. 1)

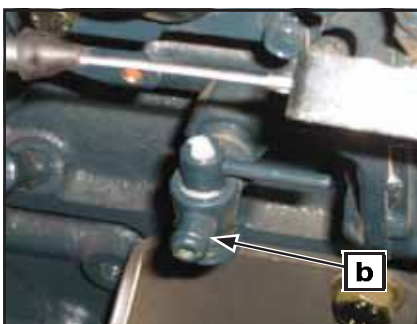

(fig. 2)

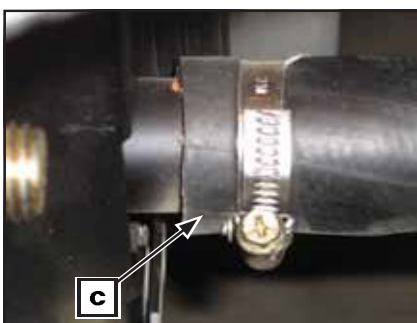

(fig. 3)



## Periodic maintenance operations

### ■ Radiator (fig. 1)

Periodically check the radiator area for its cleanliness.

#### a. Radiator fins

Check the radiator fins. They must be clean, free of mud, dirt, leaves or any other deposit that would prevent the radiators cooling properly. Never clean the radiators when hot with your bare hands. Use gloves to remove external dirtiness from the radiator. Allow the radiators to cool down before cleaning.

If water is available in the working area, rinse the radiator fins with a hose and low pressure water.

Be careful not to damage the radiators when cleaning the fins. Do not use any sharp object or tool that could damage the fins. The fins are purposely thin parts to allow efficient cooling.

See an authorised AUSA dealer to check the correct performance of the cooling system.



## WARNING



NEVER USE HIGH PRESSURE WATER, ALWAYS USE LOW PRESSURE WATER.

### 5.- Air intake system

#### ■ Cleaning the air filter (fig. 2)

The air intake to the engine is done via a dry filter. The life and performance of the engine largely depends on the correct maintenance of this filter.

Consult the frequency for renewal in the **LUBRICATION AND MAINTENANCE CHART**.

## NOTE

If the dumper is used in dusty areas, inspect the filters more frequently than specified in the **LUBRICATION AND MAINTENANCE CHART**.

## NOTE

The air filter incorporates a clogged indicator. If the indication lamp is lit on the instrument panel, clean or replace the filter element as soon as possible.

## CAUTION

Do not start the engine when water is found in the air filter box. When liquids or residues are found, the air filter must be inspected, dried or replaced independently of the condition in which it is found. Remove the air filter as explained below.



(fig. 1)



(fig. 2)

D100AHA / D100AHG  
D120AHA / D120AHG  
D150AHG



## Periodic maintenance operations

### ■ Removing the air filter (fig. 1, 2, 3)

## CAUTION

Never remove or modify any filter component. Otherwise poor performance or engine damage could occur.  
Access the filter by lifting the cover to the engine compartment.

- a. Clamps
- b. Filter element
- c. Housing

Loosen the clamps of the filter housing and remove the filter element. Clean the filter element of the accumulated dust and dirt, by blowing with pressurised air (maximum 5 bar) from inside out whilst turning. Also clean inside the filter housing.

### ■ Installing the air filter.

Assemble again all the parts following the opposite procedure of their removal.

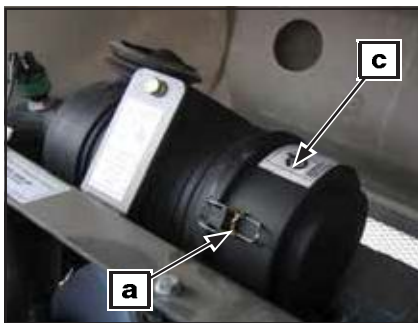

(fig. 1)



(fig. 2)

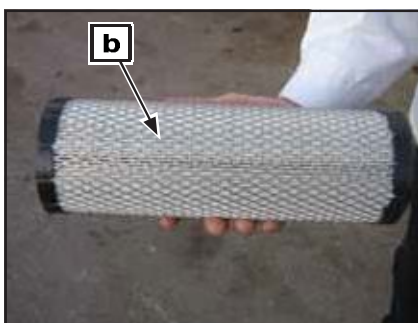

(fig. 3)



## Periodic maintenance operations

### 6.- Reducer box (fig. 1)

- a. Level and filling cap
- b. Drainage cap

#### ■ Reducer box oil level

With the vehicle on a flat surface, check the oil level in the following manner:

- Unscrew the level cap. **(a)**. The oil should spill out of the hole.
- If necessary, add oil through the same level hole.

#### ■ Changing the reducer box oil

Oil changes should be carried out when the oil is warm. Clean the area around the oil drainage plug **(b)**.

- Place a container underneath the oil drain plug.
- Change the seal in the oil drainage plug.
- Clean the transfer box seal area, the oil drainage plug and replace it.
- Refill the transfer box as per the recommended oil level. See the **LIQUIDS AND LUBRICANTS** section of the Manual for capacities.
- Ensure that there are no leaks from the oil drainage plug.



## WARNING



Clean any oil spillage.

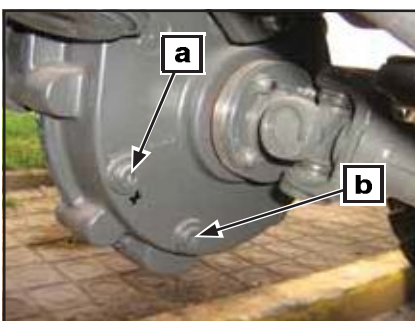

(fig. 1)

D100AHA / D100AHG  
D120AHA / D120AHG  
D150AHG



## Periodic maintenance operations

### 7.- Axle oil (fig. 1, 2)

This check should be carried out with the vehicle on a flat surface.  
The differential and reducer oils communicate internally.

- a. Level plug
- b. Filling cap
- c. Drainage cap

#### ■ Differentials

For the differential oil level, unscrew the level cap **(a)**. To empty the oil, unscrew the drainage cap **(c)**. If necessary, add oil through the filling cap **(b)**.

#### ■ Final reducers

To fill and check the level of the reducer oil, use the hexagonal cap **(b)** located on the wheel hub. Turn until the mark on the reducer is in the horizontal position. Unscrew the cap **(b)** and fill until it overflows.

To empty the oil:

- Remove the wheel.
- Place a container underneath the drainage plug **(c)**.
- Correctly position the hole on the bottom of the wheel hub.
- Unscrew the allen drainage cap **(c)**.

The **LUBRICATION AND MAINTENANCE CHART** indicates the type of oil to be used and the frequency of this operation.

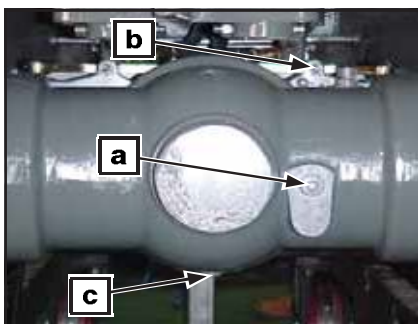

(fig. 1)

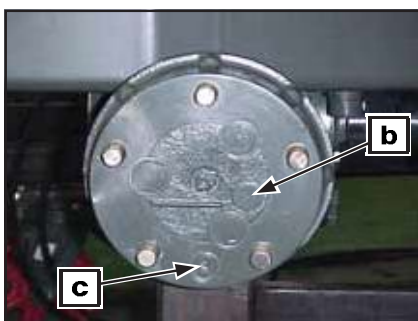

(fig. 2)



## Periodic maintenance operations

### 8.- Service and parking brake

#### ■ Service Brake

If when the service brake is activated the pedal lowers too much, it should be tightened. To do so:

- Lift the machine so that the front wheels are not in contact with the floor.
- Tighten the nuts **(a)** for both sides equally until the pedal feels correct.
- Adjust the lever limit stop **(b)** and allow play of 1mm between the lever and the limit.
- Check that the wheels turn freely.

To replace the brake discs contact an authorized AUSA dealer.

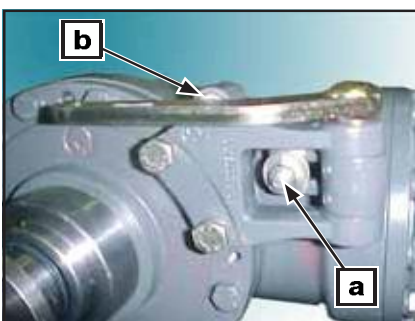

(fig. 1)

D100AHA / D100AHG  
D120AHA / D120AHG  
D150AHG



## Periodic maintenance operations

### 9.- Hydraulic circuit

#### ■ Hydraulic oil level (fig. 1, 2, )

The hydraulic oil tank is located on the left side, underneath the engine compartment cover.

- Place that the dumper is on a level surface. The oil level must always be checked with the skip in the lower position and with the engine stopped.

#### a. Filling cap and dipstick

Unscrew the filling cap which includes the dipstick. The oil level should be between the MIN. and MAX. level marks. If necessary, add oil through the same filling hole. Use a funnel to avoid spills. Place and tighten the filling cap correctly and close the cover.

### NOTE

Never exceed the maximum level.

### NOTE

A hydraulic system that requires frequent top ups indicates that there are leaks. See an authorised AUSA dealer.

#### ■ Changing the hydraulic oil (fig. 3, 4)

- b. Hydraulic oil strainer filter
- c. Tank drainage plug

Draining fuel is done via the plug situated on the lower part of the tank.

- Clean the area around the drain plug.
- Place a container underneath the oil drain plug.
- Unscrew the plug.

In the hydraulic circuit there is a strainer filter located inside the tank. It is a metallic filter which must be cleaned each time the hydraulic oil is replaced.

Change the seal and clean the magnet on the oil drainage cap. Clean the tank seal area and the oil drainage plug and replace it.

Refill the tank as per the recommended oil level. See the **LIQUIDS AND LUBRICANTS** section of the Manual for capacities.

Ensure that there are no leaks from the oil drainage plug.



### WARNING



Clean any oil spillage.

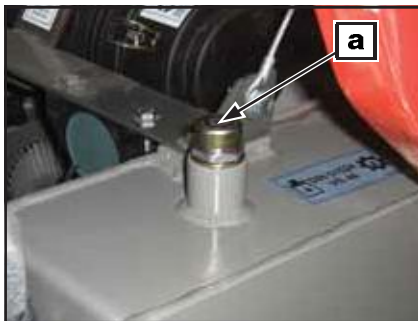

(fig. 1)

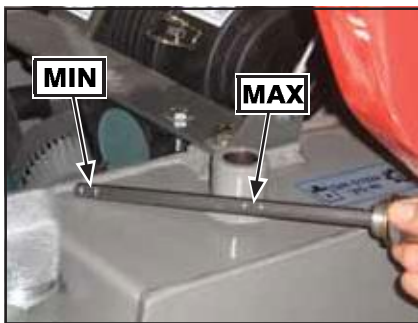

(fig. 2)



(fig. 3)

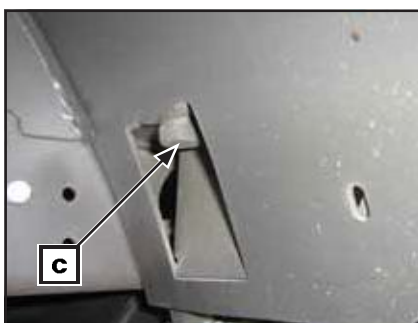

(fig. 4)



## Periodic maintenance operations



(fig. 1)



(fig. 2)

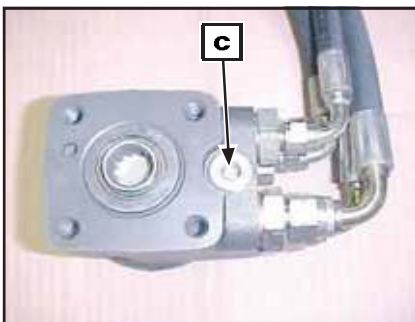

(fig. 3)



(fig. 4)

### ■ Hydrostatic transmission filter (fig. 1, 2)

The hydrostatic circuit is equipped with a filter cartridge. Replace it as often as stated indicated in the **LUBRICATION AND MAINTENANCE CHART**. The filter support is equipped with a status indicator (a vacuum meter) **(a)**. With the engine running the indicator needle should be in the green zone or in the yellow zone at the most. If it nears or reaches the red zone, replace the filter cartridge as soon as possible.

- a. Vacuum meter
- b. Cartridge filter

### ■ Replacing the cartridge filter.

Release the filter **(b)**. Clean the base and cover the seal of the new filter with clean oil. Screw it to the support and tighten by hand.



## WARNING



Ensure that you correctly tighten the filter cartridge **(b)** as serious damage could be caused to the hydrostatic transmission if not.

### ■ Safety valve regulation (fig. 3, 4)

There are two safety valves to avoid over pressures in the steering circuit and the load handling systems.

- c. Hydraulic steering block safety valve
- d. Load handling system safety valve

The first is located on the hydraulic steering and the second is externally connected to the control valve. These valves are set at the correct working pressure in factory, but the settings need to be checked periodically and adjusted if necessary. This work must only be done by trained mechanics with knowledge of hydraulics and with the appropriate tools. Pressures should never exceed those indicated in the **SPECIFICATIONS** section of this Manual.

- **Hydraulic steering circuit valve:** Remove the cap by unscrewing it and turn the internal screw with a screwdriver in a clockwise direction to increase the hydraulic pressure and anti-clockwise to reduce it.
- **Load handling circuit valve:** Loosen the locknut and turn the screw in a clockwise direction to increase the hydraulic pressure and anti-clockwise to reduce it.

### ■ Hydraulic hoses

All hydraulic hoses must be changed at least every 6 years.



D100AHA / D100AHG  
D120AHA / D120AHG  
D150AHG



## Periodic maintenance operations

### 10.- Electrical circuit

#### ■ Battery

To access the battery, lift the engine compartment cover. The battery is located beneath the engine compartment to the left. Check that the battery has no external damage, lifted plates or electrolyte leaks. Check the electrolyte density. It should have a value of between 1.27 and 1.28.

Clean the battery terminals of rust. Apply dielectric grease or vaseline on the positive post to protect it from rust.

## WARNING

Never charge the battery when it is mounted on the dumper.

#### ■ Battery isolator (fig. 1)

There is a battery isolator on the negative terminal (-). Disconnection of the battery is recommended during repairs to the electrical installation, welding and long storage periods.

#### ■ Fuses.

If a fuse is damaged, replace it with another fuse of the same amps.

## CAUTION

Do not use fuses with higher amps, this may cause important damage. The fuses are located in a box above the positive terminal of the battery and on the instrument and control panel in front of the operator.

#### ■ Fuses in the box above the positive post of the battery (fig. 2)

FG1: Instrument and control panel permanent live fuse .....	(50A)
FG2: Preheating control box positive .....	(50A)
FG3: + starter relay fuse .....	(50A)
FG4: General fuse .....	(200 A)

#### ■ Instrument and control panel fuses (fig. 3)

F1: Permanent live warning lights fuse .....	(7.5A)
F2: Reverse gear acoustic signal / left side lights fuse .....	(5A)
F3: Right side lights fuse .....	(5A)
F4: Low beam fuse .....	(10A)
F5: High beam lights fuse .....	(10A)
F6: Joystick switches power supply fuse .....	(7.5A)
F7: Front / rear solenoids + horn .....	(10A)
F8: Alternator positive / engine stop solenoid .....	(10A)
F9: Instrument and control panel lamps .....	(7.5A)
F10: Rotating beacon fuse .....	(15A)
F11: Optionals fuse .....	(10A)



(fig. 1)

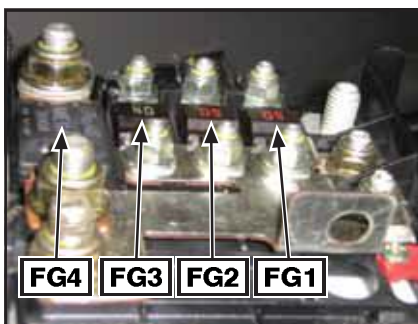

(fig. 2)



(fig. 3)



## Periodic maintenance operations

### ■ Checking the fuses (fig. 1)

Check whether the internal filament is blown.

#### TYPICAL PROCESS

- a. Fuse
- b. Check if it is blown.

### 11.- Wheels

Unless it is essential for the type of work to be carried out, the use of solid tyres is not recommended, as this increases the effects of impacts on the transmission and the operator.

Occasionally, the wheel nuts must be removed in order to apply lubricant. This operation is very important when the dumper is used in salt water or muddy environments. Remove the wheel nuts one by one, lubricate each one and screw them on again.

### ■ Re-tighten the wheels

Weekly or every 50 hours of operation, the wheel nuts should be retightened.

**Wheel nut torque loading:** 250 ± 30 Nm.

### ■ Tyre pressure



## WARNING



Tyre pressure largely affects the steering and stability of the dumper. A low tyre pressure in the tyres could make them deflate and spin out. A high pressure in the tyre can make it blow out. Always follow the recommended pressure. As the tyre pressure is high, do not use a manual pump. Inflating the wheels could be dangerous if the operation is not carried out with caution. If possible, it is recommended that this operation be carried out by specialists in the field.

We recommend that you follow the operations below, particularly for rear tyres.

- Park the dumper on flat ground with the engine off.
- Always inflate the tyres when they are cold, to the pressure indicated in the **SPECIFICATIONS** section of this manual before beginning work with the dumper.
- Tyre pressure changes according to the temperature and altitude. Recheck the pressure if one of these conditions changes.
- Checking the pressure and inflating the tyre, must be carried out with a pressure meter in good operational condition and equipped with a nozzle which has a safety clamp, to avoid it slipping from the tyre valve during inflation.
- Use gloves to avoid any injury to the hands by any incorrect function of the air nozzle.
- If the tyre is being inflated away from the dumper, first protect it with a special protection cage designed for this purpose.

Carrying an anti-puncture repair kit is recommended.

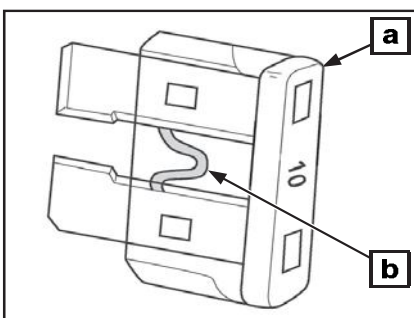

(fig. 1)

D100AHA / D100AHG  
D120AHA / D120AHG  
D150AHG



■ **Tyre/Wheel condition**

Check the tyres for possible damage or wear. Replace if necessary. Do not rotate the tyres if they are directional. For correct operation their rotation must maintain a specific direction.

■ **Removing the wheel (fig. 1)**

Loosen the nuts and raise the dumper. Place a support beneath it. Remove the nuts and then remove the wheel.

When assembling, apply lubricant to the threads. Slowly tighten the nuts in a criss-cross sequence, applying a final torque of  $250 \pm 30$  Nm.

**a. Coned part of the wheel nut**

	<b>WARNING</b>	
Always use the recommended wheel nuts. Using a different nut could cause damage to the wheel.		

**12.- Cable lubrication (fig. 2)**

All cables must be lubricated with cable lubricant.

	<b>WARNING</b>	
Using any other lubricant may cause the cable or control to malfunction (accelerator pedal, service and parking brake, etc.). Always wear eye protectors and gloves when lubricating cables.		

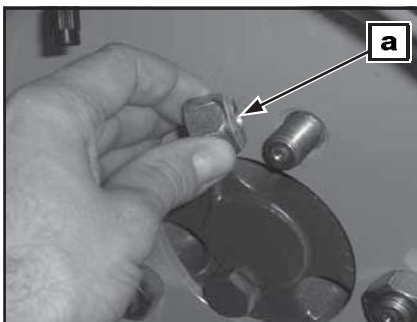

(fig. 1)



(fig. 2)



### 13.- Body/Chassis

#### ■ Engine Area

Check the engine compartment to see if there is any damage or leak. Ensure that all rubber hoses are free from cuts, splits, cracks or damage of any kind and that the fittings are correctly fitted. Examine the support devices of exhaust, battery and tanks. Check electrical connections for corrosion of false connections. Replace or repair damaged parts.

Chassis supports Check the condition and tighten all dumper supports. Retighten if necessary.

#### ■ Seat belts

Check the fixture and locking of seatbelts. Before starting the day, carefully inspect this device with special attention to:

- Cuts or threading on the belt.
- Wear or damage to anchor points
- Poor functioning of the seat belt buckle or the retracting roller
- Loose threads or poor stitching

Consult an authorized AUSA dealer for the replacement of damaged parts.

#### ■ Dumper cleaning and protection

Never use water at high pressure to clean the dumper. ONLY USE LOW PRESSURE WATER. High pressure water can cause electrical and mechanical damage. Damaged painted parts must be repainted to prevent corrosion. When required, wash the body with soap and water (use only neutral soap). Apply non abrasive wax.

## CAUTION

Never clean plastic parts with inappropriate detergent, degreasing agents, solvents, acetone, etc.



**D100AHA / D100AHG**  
**D120AHA / D120AHG**  
**D150AHG**



## Maintenance and lubrication chart

	EVERY												
	Initial inspection (60 h)	100 h.	200 h.	400 h.	500 h.	800 h.	1000 h.	1500 h.	3000 h.	Week	Month	Year	2 years
<b>I:</b> Inspect, verify, clean, lubricate, replace if necessary													
<b>C:</b> Clean													
<b>L:</b> Lubricate													
<b>R:</b> Replace													
<b>ENGINE</b>													
Oil and oil filter (1)	R		R										
Engine supports / fixtures			I										
Leaks / damage / exhaust system supports									I				
Valve clearance (6)						I							
Engine operation / idle / max. R.P.M./ vibrations			I										
Control / condition / leaks / components in the engine compartment									I				
Alternator belt			I		R								R
<b>COOLING SYSTEM</b>													
Check the pressure of the cooling system (6)				I									
Radiator condition / external radiator cleaning (4)			I						C				
Radiator hoses and clamp bands			I										R
Water jacket (radiator interior)					C								
Coolant liquid (3) (6)									I				R
<b>FUEL / COMBUSTION CIRCUIT</b>													
Air filter and housing (4)		C			R(5)							R	
Air entry tube to the air filter (6)			I										R
Fuel conducts / connections / fixtures									I				R(2)
Fuel filter cartridge (6)				R									
Fuel pre-filter (1)	R		R										
Fuel tank (6)					C								
Injection pressure at the fuel injection nozzle (2) (6)								I					
Injection pump (timing) (2) (6)									I				
Fuel injection timer (2) (6)									I				
<b>ELECTRICAL SYSTEM</b>													
Battery electrolyte	I	I											
Battery connections									I				
Dash panel indicators / Warning lights (3)									I				
Battery										I			R
Damage to harness and loose connections											I		

- (1) First inspection Initial maintenance is very important and must not be neglected.
- (2) To be carried out by an authorised AUSA dealer.
- (3) Daily inspection item.
- (4) More often in severe operating conditions such as sandy or dusty areas, areas with snow, or wet or muddy areas.
- (5) ...or after cleaning 6 times
- (6) Replace only when necessary



	EVERY												
	Initial Inspection (50 h)	100 h.	200 h.	400 h.	500 h.	800 h.	1000 h.	1500 h.	3000 h.	Week	Month	Year	2 years
<b>I:</b> Inspect, verify, clean, lubricate, replace if necessary													
<b>C:</b> Clean													
<b>L:</b> Lubricate													
<b>R:</b> Replace													
<b>HYDRAULIC CIRCUIT</b>													
Oil, admission filter and drainage cap magnet (3)	R/C					R/C				I			
Hydraulic filter cartridge (1)	R					R							
Skip movements (3)										I			
Damage or leaks to pipes, hoses and fittings			I										
Steering movements (3)										I			
Replacement of hydraulic hoses	REPLACE AT LEAST EVERY 6 YEARS												
<b>GREASING POINTS</b>													
Central pivot										L			
Nipples (see greasing points)										L			
Control articulations (accelerator, lifting cylinders, etc.)										L			
<b>TRANSFER BOX</b>													
Oil (1)	R						R			I		R	
Oil leaks										I			
Tightness of all nuts and bolts										I			
<b>AXLES (FRONT AND REAR)</b>													
Oil (1)	R						R			I		R	
Oil leaks										I			
Tightness of wheel nuts										I			
Tightness of chassis fixing screws						I							
Wheel hub bearing adjustment						I							
Tighten coupling fixture nuts and universal drive shaft joint											I		
Tyre condition and pressure										I			
<b>BRAKES</b>													
Service brake tightening and adjustment (3)										I			
Parking brake tension (3)	I									I			
<b>BODY / CHASSIS</b>													
ROPS Arch										I			
Safety belt (3)										I			
Floor panel and access step (3)										I/C			
Body and protectors (3)										I			
Plates and labels (3)										I			
Tightening of the central articulation nut							I						
Safety system / frame joint lock and hopper lowering lock										I			
Engine compartment cover lock										I			

- (1) First inspection Initial maintenance is very important and must not be neglected.
- (2) To be carried out by an authorised AUSA dealer.
- (3) Daily inspection item.
- (4) More often in severe operating conditions such as sandy or dusty areas, areas with snow, or wet or muddy areas.
- (5) ...or after cleaning 6 times
- (6) Replace only when necessary

D100AHA / D100AHG  
D120AHA / D120AHG  
D150AHG



## Greasing points

### ■ GREASING POINTS

- 2 nipples on the central chassis articulation (**fig. 2**).
- 2 nipples on the steering ram (**fig. 1**)
- 2 nipples, one on each cross of the universal drive shaft joints.
- 2 nipples on each ram, one on each articulation pin
- 1 nipple on each articulation of the skip lifting (**fig. 3, 4, 5**) or turning system (**fig. 6**) depending on the model.



(fig. 1)

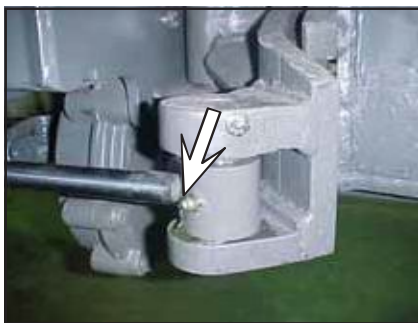

(fig. 2)



(fig. 3)



(fig. 4)

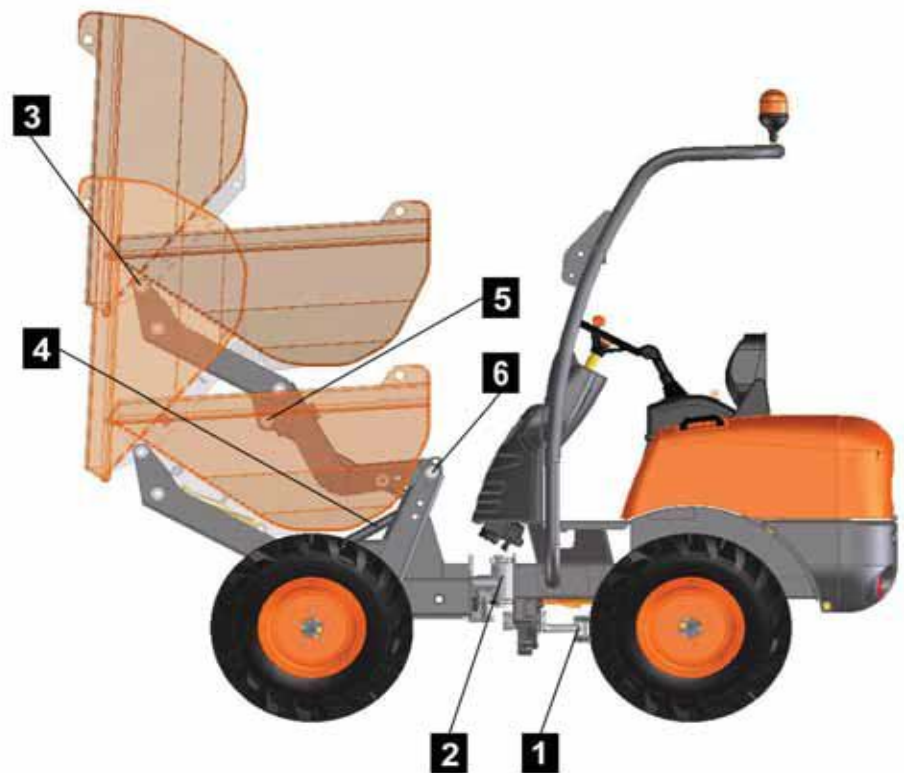

(fig. 5)



(fig. 6)



## Wiring diagram

WIRE COLOURS	
A	Light Blue
B	White
C	Orange
G	Yellow
H	Gray
L	Blue
M	Brown
N	Black
R	Red
S	Pink
V	Green
Z	Violet
	Single color wire
	Two lengthways colors wire
	Two crossways colors wire

**NOTE:** the colors of the two-colored cables are indicated by the signals painted above them.  
For example:

Y-G: Yellow / Green with transversal marks  
Y/G: Yellow / Green with lengthways marks





D100AHA / D100AHG  
D120AHA / D120AHG  
D150AHG



55

# Wiring diagram

1

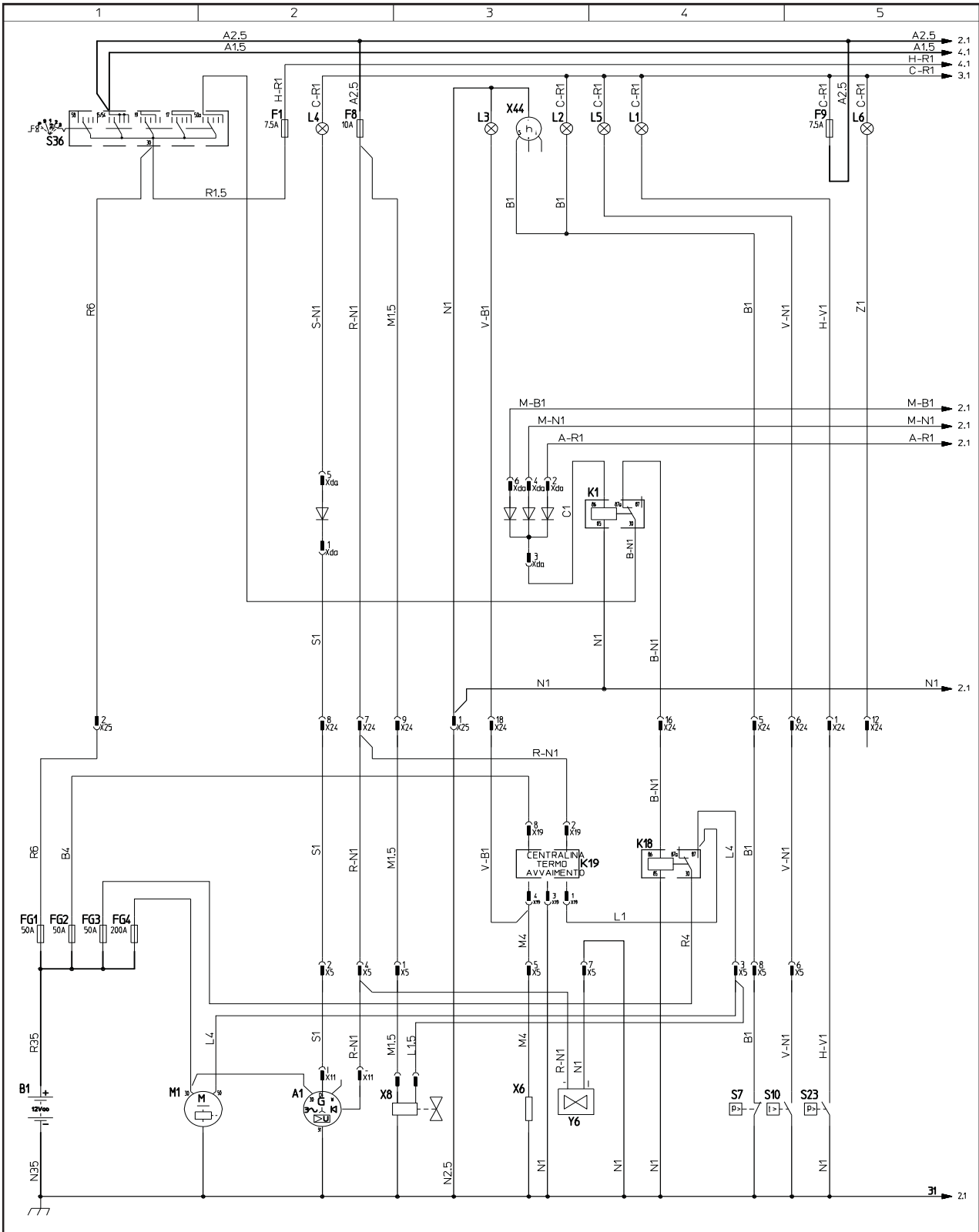



56



D100AHA / D100AHG  
D120AHA / D120AHG  
D150AHG

## Wiring diagram

2

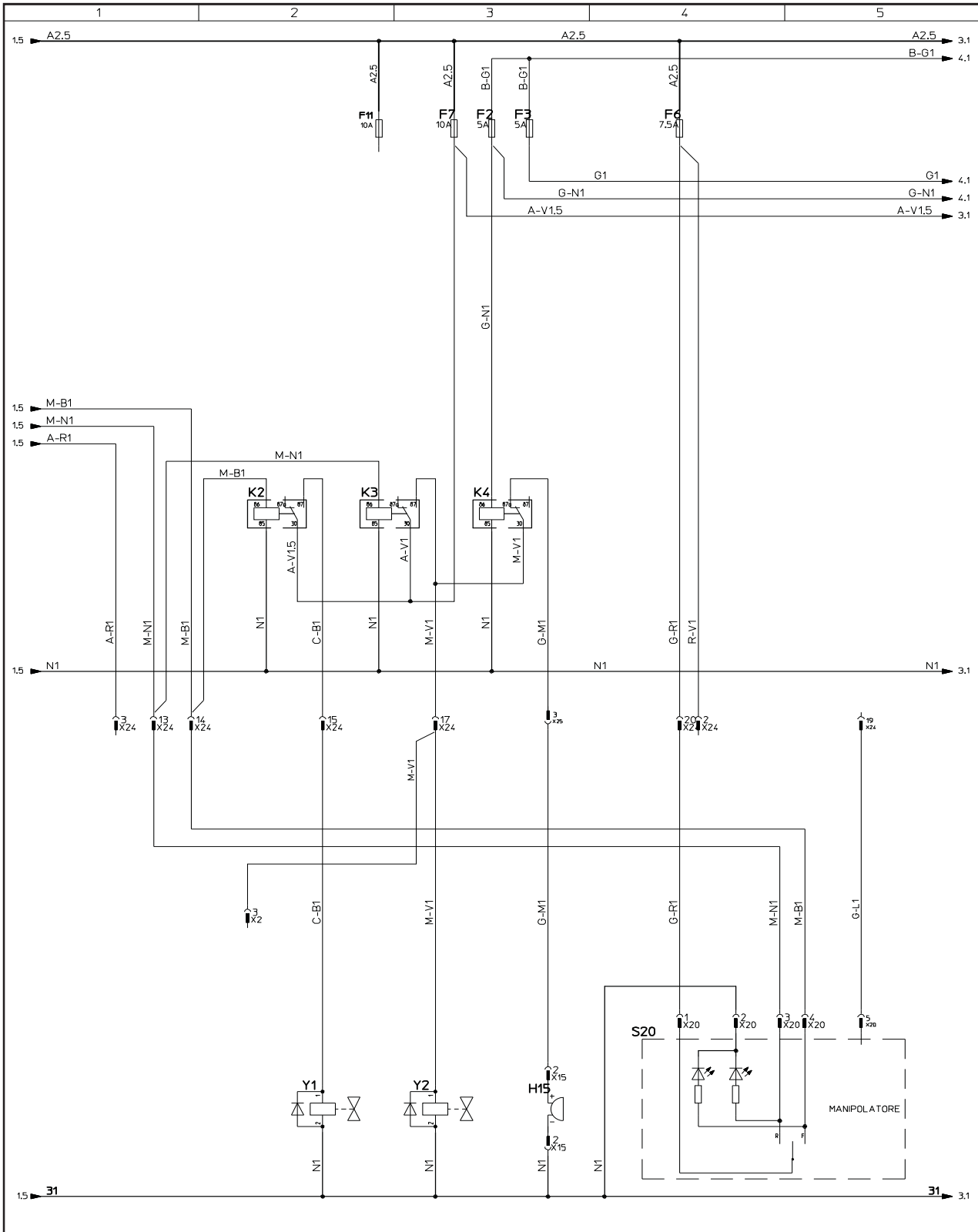



D100AHA / D100AHG  
D120AHA / D120AHG  
D150AHG



# Wiring diagram

3

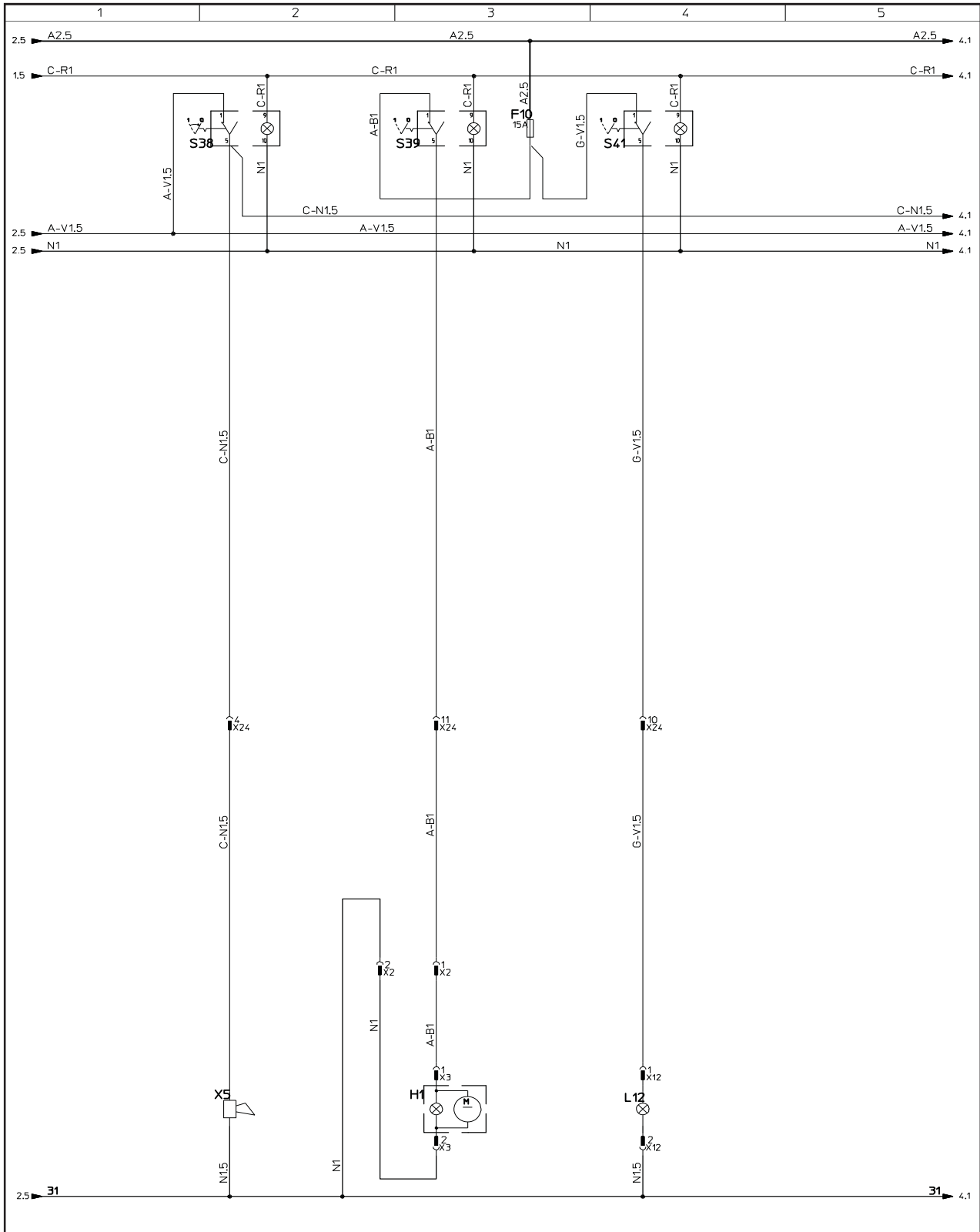



**Wiring diagram**

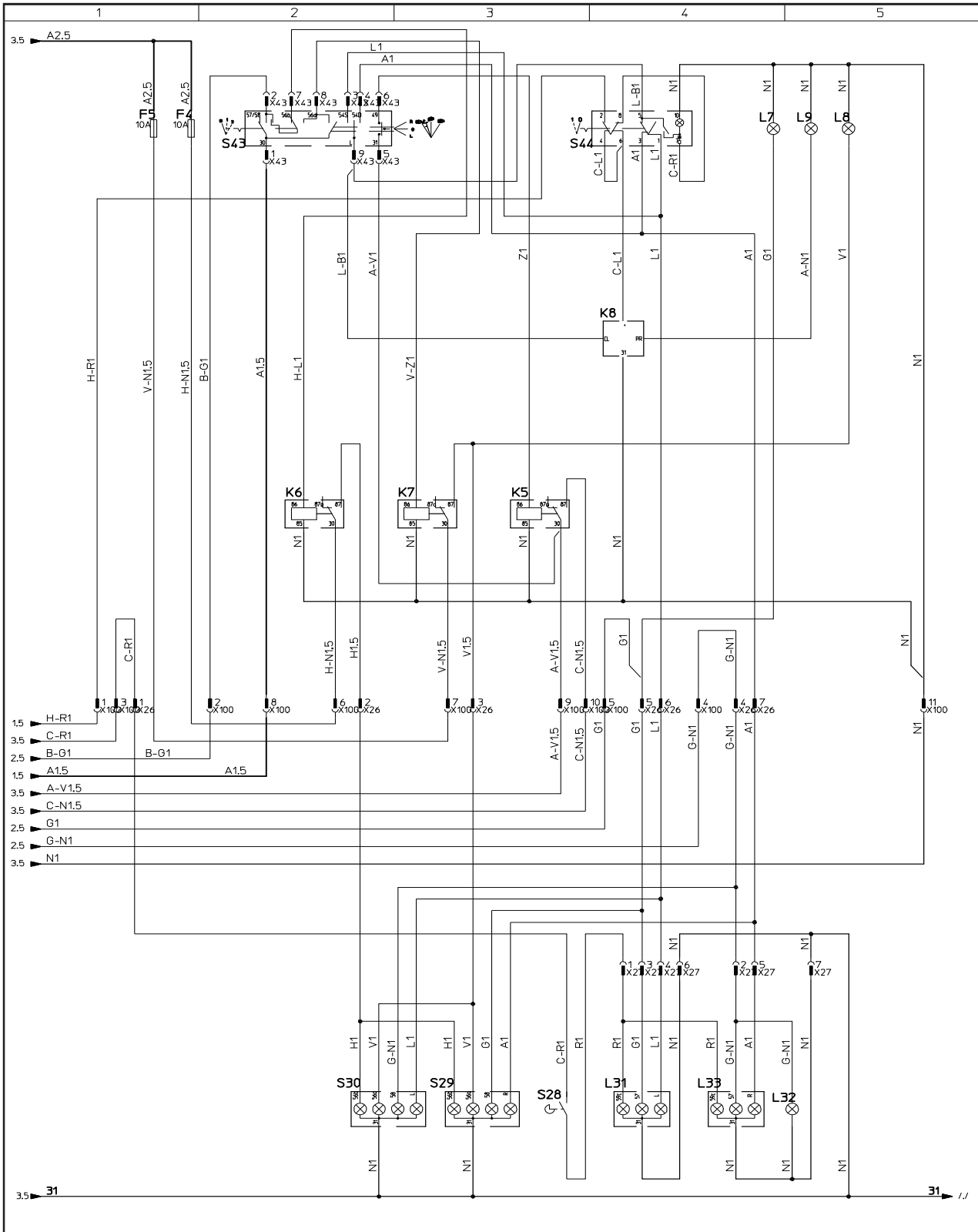



**D100AHA / D100AHG**  
**D120AHA / D120AHG**  
**D150AHG**



## Wiring diagram

Item	Description	Page
A1	Alternator	1
B1	Battery	1
B7	Engine oil pressure switch	1
B10	Coolant temperature warning switch	1
B13	Horn	3
B23	Air filter blockage indicator	1
B28	Brake lights switch	4
E2	Rotating/flashing beacon	3
E12	Work lights	3
E29	Right hand headlight	4
E30	Left hand headlight	4
E31	Rear left hand light	4
E32	Number plate light	4
E33	Rear right hand light	4
F1	Permanent live warning lights fuse (7,5A)	1
F2	Left side light (5A)	2
F3	Right side light (5A)	2
F4	Low beam fuse (10A)	4
F5	High beam fuse (10A)	4
F6	Joystick switches fuse (7,5A)	2
F7	Forward and Reverse switch (joystick) and relays (dash panel) (10A)	2
F8	Stop solenoid fuse (10A)	1
F9	Ignition feed warning lights switch / brake lights switch fuse (7,5A)	1
F10	Flashing / rotating beacon and working lights fuse (15A)	3
F11	Optional fuse (10A)	3
FG1	Permanent live main fuse (50A)	1
FG3	Starter motor relay main fuse (50A)	1
FG2	Pre-heat relay main fuse (50A)	1
FG4	Starter motor fuse (200A)	1
H1	Air filter warning light	1
H2	Engine oil pressure warning light	1
H3	Preheating warning light	1
H4	Battery charge warning light	1
H5	Coolant temperature warning light	1
H6	Low fuel level warning light	1
H7	Sidelights indicator lamp	4

Item	Description	Page
H8	High beam indicator lamp	4
H9	Blinker indicator lamp	4
H15	Reverse alarm	2
K1	Neutral start relay	1
K2	Forward relay	2
K3	Reverse relay	2
K4	Reverse alarm relay (night silence)	2
K5	Horn relay	4
K6	Low beam relay	4
K7	High beam relay	4
K8	Flasher relay	4
K18	Starter motor relay	1
K19	Pre-heat relay	1
M9	Starter motor	1
P44	Hourmeter	1
R6	Pre-heater plugs	1
S20	Joystick	2
S36	Ignition barrel	1
S38	Horn switch	3
S39	Flashing beacon switch	3
S40	Warning light switch	4
S41	Working lights switch	3
S43	Sidelight switch	4
X??	Connector number ??	1-4
Y1	Forward solenoid	2
Y2	Reverse solenoid	2
Y8	Stop solenoid	1



## Hydraulic diagram AHA (Auxiliaries)

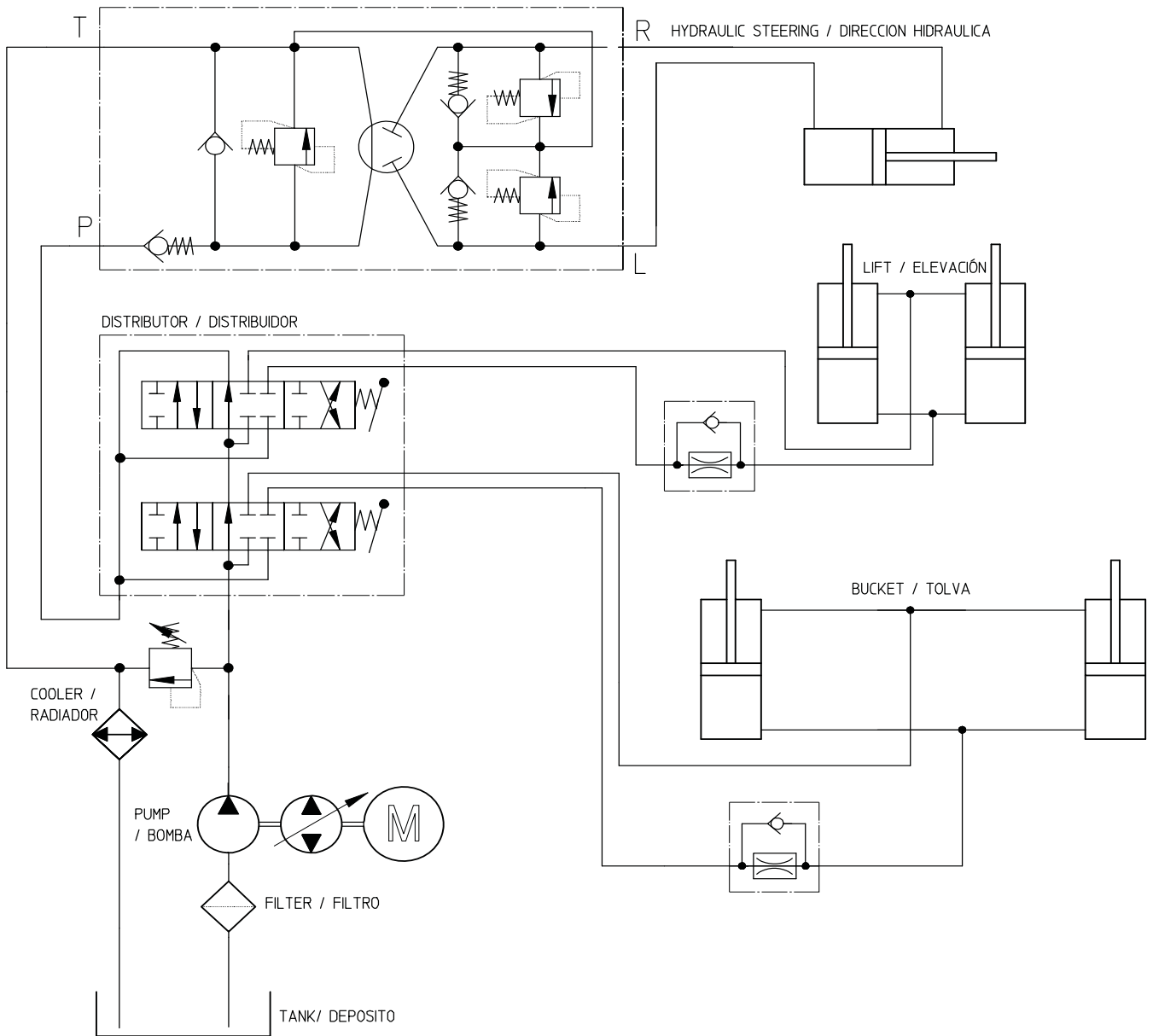



D100AHA / D100AHG  
D120AHA / D120AHG  
D150AHG



## Hydraulic diagram AHG (Auxiliaries)

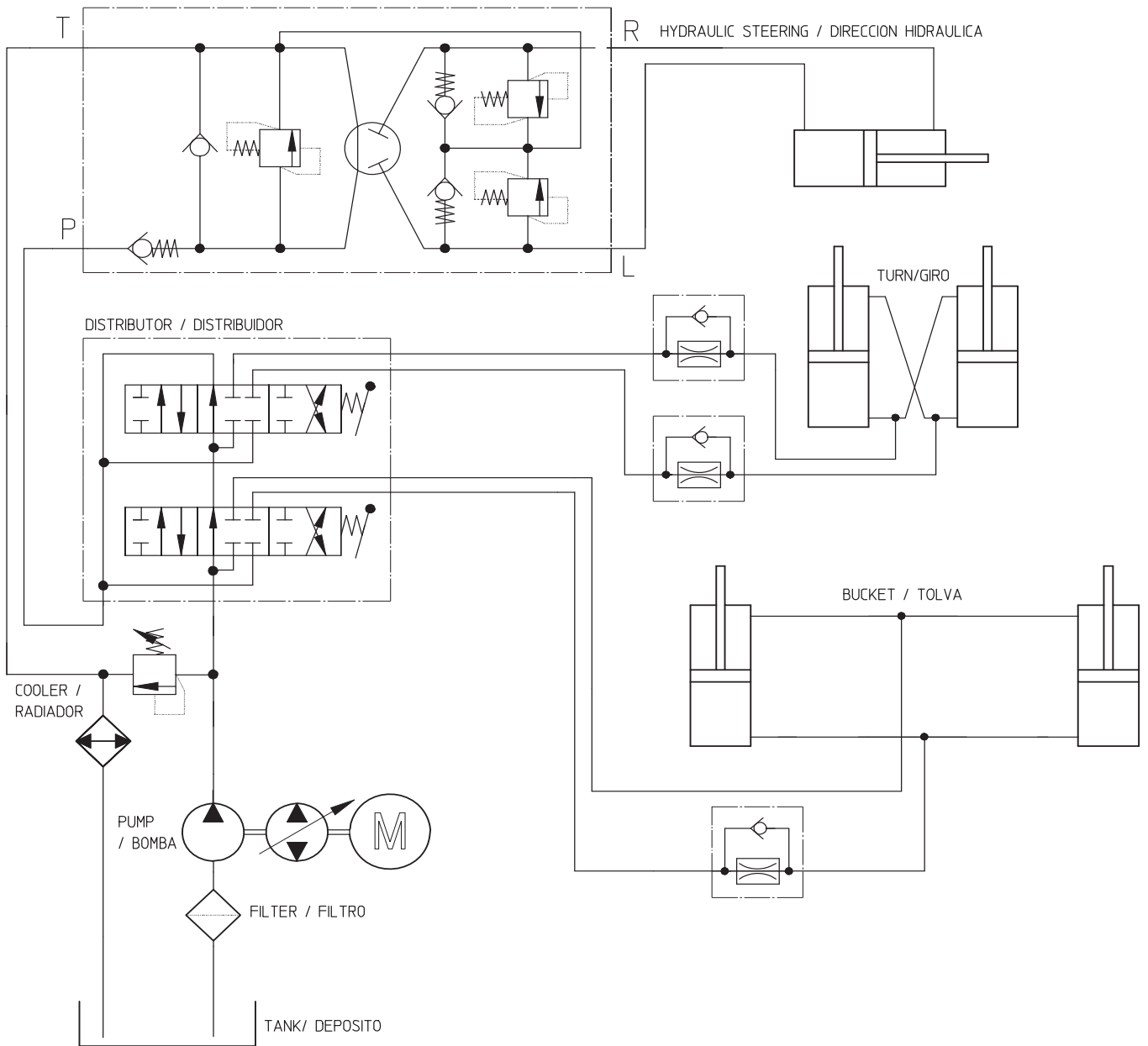



## REXROTH hydraulic diagram (Transmission)

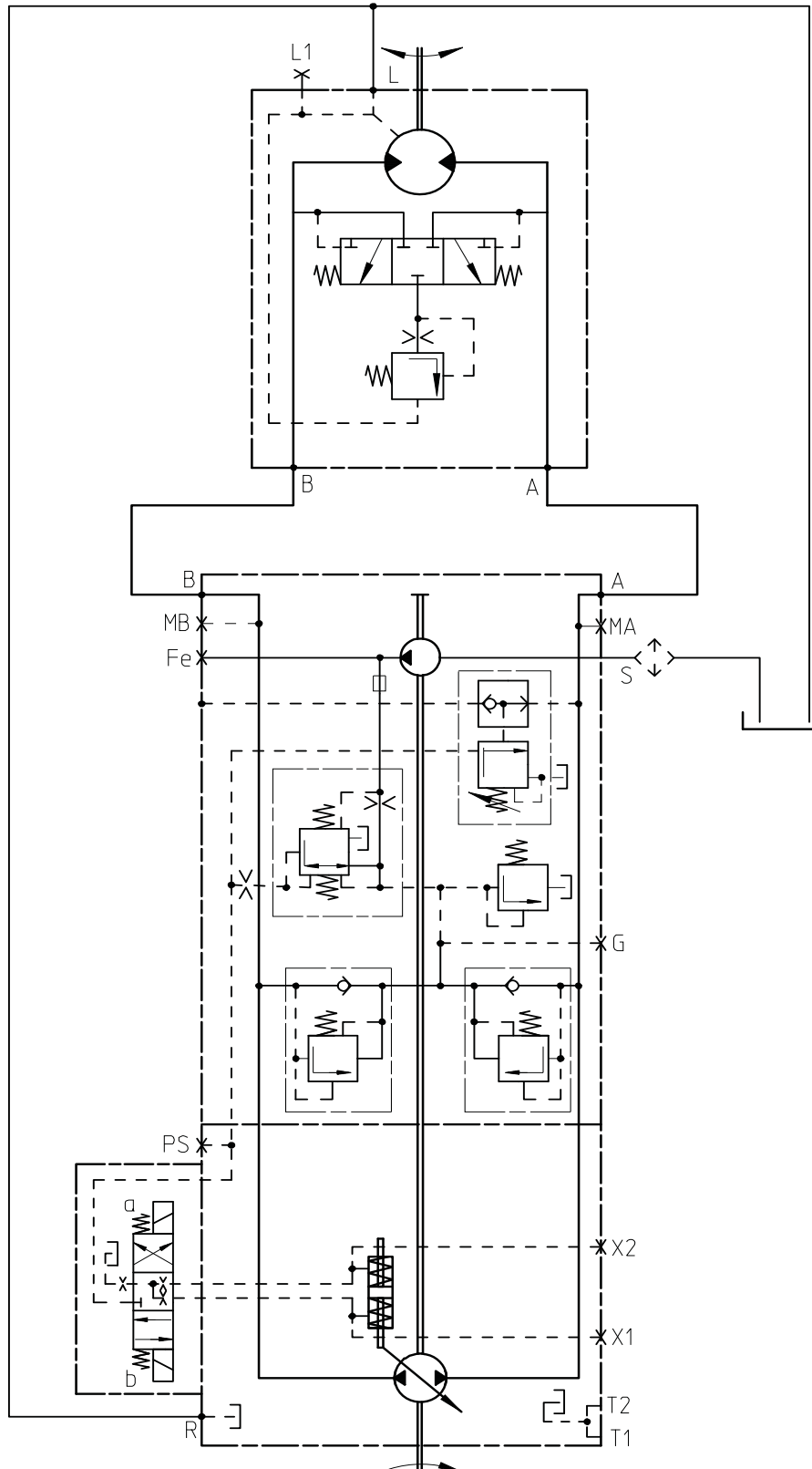



D100AHA / D100AHG  
D120AHA / D120AHG  
D150AHG



63

## SAUER hydraulic diagram (Transmission)

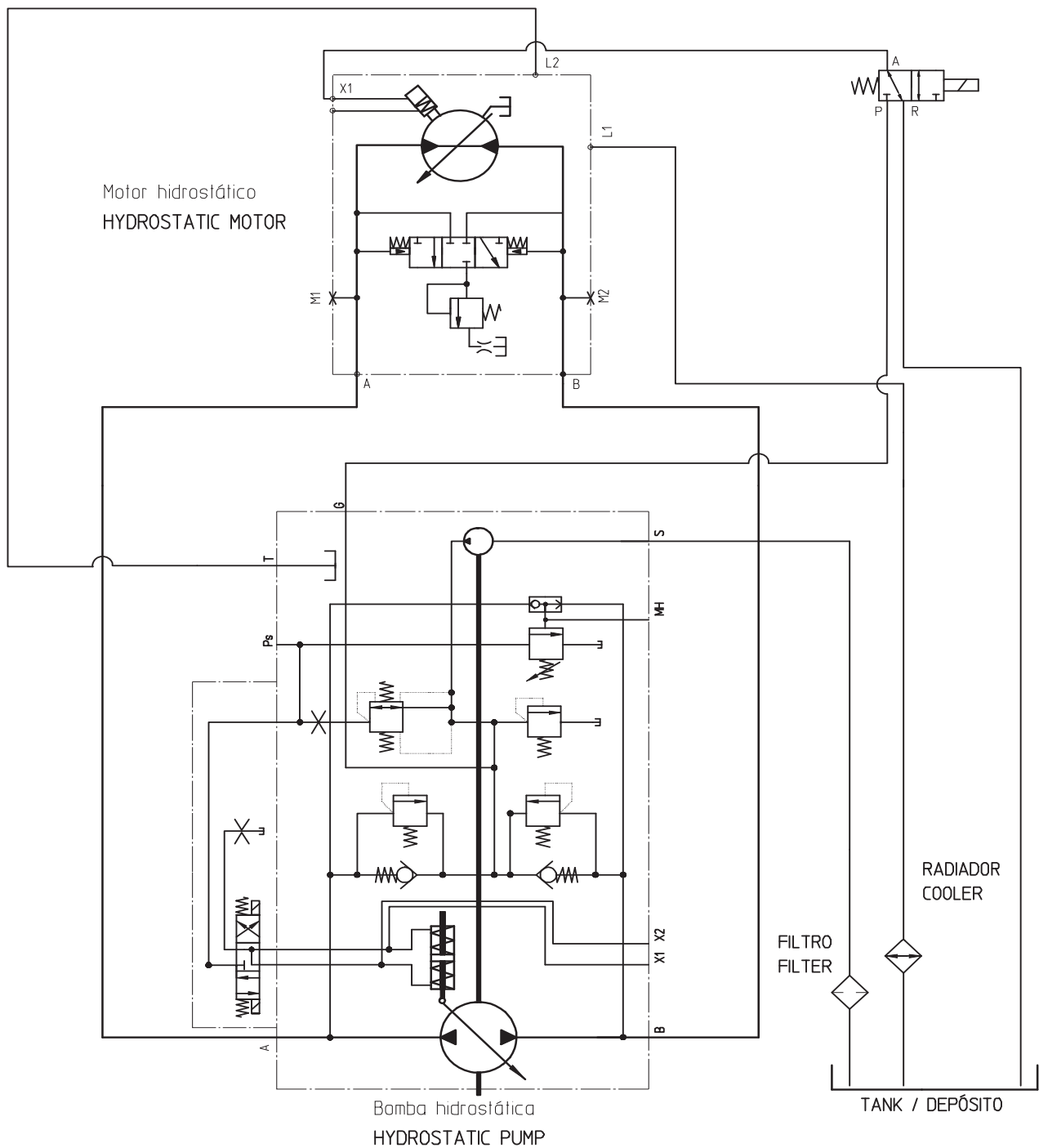

**DUPLICATE****EC DECLARATION OF CONFORMITY**

The manufacturer **AUSA Center, S.L.U.**, established on Ctra. de Vic, km 2.8, 08243 – Manresa – Barcelona – Spain, declares that the machine assigned below:

Generic denomination: **DUMPER**

Model/Type:

Serial number: **XXXXXXXX**

fulfils all relevant provisions of the machinery Directive 2006/42/EC

and it conforms with the next European Directives:

Electromagnetic Compatibility Directive 2004/108/EC

Sound level Directives of machinery used outdoors, 2000/14/EC and 2005/88/EC

Exhaust emissions Directives, 97/68/EC and 2004/26/EC

based on the following European Standards:

EN 474-1 – Earth-moving machinery – Safety – Part 1: General requirements.

EN 474-6 – Earth-moving machinery – Safety – Part 6: Requirements for dumpers.

The certification procedure has been carried out in accordance with the provisions relating to non-dangerous machinery in the above mentioned Directives.

Name and address of the person authorized to compile the technical file:

Mr. **Antoni Tachó Figuerola**

Ctra. De Vic, km 2.8, 08243, Manresa, Barcelona, Spain

Signed by Mr.

Given at Manresa on **dia/mes/**



**AUSA Center, S.L.U.**  
Cra. de Vic, Km. 2,8 - P.O.B. 194  
08243 MANRESA (Barcelona) España

Tel. 34-93 87 47 311  
Fax 34-93 874 12 11  
Web: <http://www.ausa.com>



